



LED UFO HIGH BAY WITH Q-BASE

► **DESIGN** - LED UFO HIGH BAY WITH Q-BASE is extremely efficient with a 170lm/W output. The built-in motion sensor base allows you to install the microwave motion or PIR sensor. Die-cast aluminum housing with excellent heat dissipation along with an anti-glare PC lens provide many years of use. It can operate in temperatures ranging from -40 to 140°F. With 6kV surge protection, it runs on 120-277V or 277-480V circuits with a 0-10V dimmable driver.

► **IP69K** - Rating provides protection against ingress of dust and high temperature, high pressure water.

► **COLOR AND POWER SELECTABLE** - You can choose either a 3,000K warm white, 4,000K cool white or 5,000K daylight color temperature, and change the power with a simple switch.

► **INSTALLATION** - This fixture has three different mounting options: suspended, surface, and pendant. It comes with 4 ft cord. Perfect commercial or industrial solution for warehouses, supermarkets, retail stores, gyms, and many other applications.

► **ADVANTAGES** - With calculated lifespan up to 141,000 hours, these fixtures are made to last decades under normal operation! ASD provides a 5-year limited warranty along with UL and DLC Premium certifications to guarantee top quality products and safety!

Catalog number	
Notes	
Type	

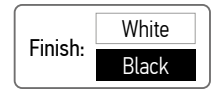

Model	Watts	Voltage	Dimmable	Lumens	CCT	Finish	Dimensions (LxWxH)	Cord	
UHB5-PRO									
ASD-UHB5-PRO-100BK	60/80/100W	120-277 V	0-10 V	up to 17,580 lm	3CCT (3,000/4,000/5,000 K)	Black	9-1/16" x 9-1/16" x 4-5/8"	4 ft	
ASD-UHB5-PRO-150WH	100/120/150W	120-277 V	0-10 V	up to 26,331 lm	3CCT (3,000/4,000/5,000 K)	White	9-1/16" x 9-1/16" x 4-11/16"	4 ft	
ASD-UHB5-PRO-150BK	100/120/150W	120-277 V	0-10 V	up to 26,331 lm	3CCT (3,000/4,000/5,000 K)	Black	9-1/16" x 9-1/16" x 4-11/16"	4 ft	
ASD-UHB5-PRO-200WH	100/150/200W	120-277 V	0-10 V	up to 33,575 lm	3CCT (3,000/4,000/5,000 K)	White	12-3/16" x 12-3/16" x 5-3/8"	4 ft	
ASD-UHB5-PRO-200BK	100/150/200W	120-277 V	0-10 V	up to 33,575 lm	3CCT (3,000/4,000/5,000 K)	Black	12-3/16" x 12-3/16" x 5-3/8"	4 ft	
ASD-UHB5-PRO-240BK	150/200/240W	120-277 V	0-10 V	up to 40,557 lm	3CCT (3,000/4,000/5,000 K)	Black	12-3/16" x 12-3/16" x 5-7/16"	4 ft	
ASD-UHB5-PRO-300BK	200/240/300W	120-277 V	0-10 V	up to 49,914 lm	3CCT (3,000/4,000/5,000 K)	Black	13" x 13" x 5-11/16"	4 ft	
ASD-UHB5-PRO-500BK	300/400/500W	120-277 V	0-10 V	up to 82,551 lm	3CCT (3,000/4,000/5,000 K)	Black	16-9/16" x 16-9/16" x 6-15/16"	4 ft	
UHB5-HV-PRO HIGH VOLTAGE									
ASD-UHB5-HV-PRO-150BK	100/120/150W	277-480 V	0-10 V	up to 25,842 lm	3CCT (3,000/4,000/5,000 K)	Black	9-1/16" x 9-1/16" x 4-3/4"	4 ft	
ASD-UHB5-HV-PRO-200BK	100/150/200W	277-480 V	0-10 V	up to 34,126 lm	3CCT (3,000/4,000/5,000 K)	Black	12-3/16" x 12-3/16" x 5-7/16"	4 ft	
ASD-UHB5-HV-PRO-240BK	150/200/240W	277-480 V	0-10 V	up to 41,331 lm	3CCT (3,000/4,000/5,000 K)	Black	12-3/16" x 12-3/16" x 5-7/16"	4 ft	
ASD-UHB5-HV-PRO-300BK	200/240/300W	277-480 V	0-10 V	up to 51,514 lm	3CCT (3,000/4,000/5,000 K)	Black	13" x 13" x 5-3/4"	4 ft	
ASD-UHB5-HV-PRO-500BK	300/400/500W	277-480 V	0-10 V	up to 82,905 lm	3CCT (3,000/4,000/5,000 K)	Black	16-9/16" x 16-9/16" x 7-13/16"	4 ft	
SENSORS AND REMOTE									
ASD-09MW-WH	Microwave motion sensor 3pin white							2-1/8" x 2-1/8" x 1-5/16"	-
ASD-09MW-BK	Microwave motion sensor 3pin black							2-1/8" x 2-1/8" x 1-5/16"	-
ASD-09IR-WH	Infrared motion sensor 3pin white							2-1/8" x 2-1/8" x 1-11/16"	-
ASD-09IR-BK	Infrared motion sensor 3pin black							2-1/8" x 2-1/8" x 1-11/16"	-
ASD-06RC	Remote control for motion sensor							5-11/16" x 1-3/4" x 13/16"	-
ASD-09MW-NLS-WH	Microwave motion sensor smart 3pin white							2-1/8" x 2-1/8" x 1-3/8"	-
ASD-09IR-NLS-WH	Infrared motion sensor smart 3pin white							2-1/8" x 2-1/8" x 1-11/16"	-
ASD-06RC-NLS	Remote control for motion sensor smart							5-11/16" x 1-3/4" x 13/16"	-

For detailed luminous flux information please refer to Annex 1.

For most up-to-date spec sheets please refer to asd-lighting.com



LED UFO HIGH BAY WITH Q-BASE

PRODUCT SPECIFICATIONS:

Construction & Materials						
Housing	Aluminum					
Lens	PC					
Finish	White, Black					
Weight	ASD-UHB5-PRO-100BK	4.1 lbs (1.9 kg)	ASD-UHB5-PRO-200BK	6.3 lbs (2.9 kg)	ASD-UHB5-HV-PRO-150BK	5.2 lbs (2.4 kg)
	ASD-UHB5-PRO-150WH	4.4 lbs (2 kg)	ASD-UHB5-PRO-240BK	6.9 lbs (3.1 kg)	ASD-UHB5-HV-PRO-200BK	6.6 lbs (3 kg)
	ASD-UHB5-PRO-150BK		ASD-UHB5-PRO-300BK		ASD-UHB5-HV-PRO-240BK	
	ASD-UHB5-PRO-200WH	6.3 lbs (2.9 kg)	ASD-UHB5-PRO-500BK	18.1 lbs (8.2 kg)	ASD-UHB5-HV-PRO-300BK	7.3 lbs (3.3 kg)
					ASD-UHB5-HV-PRO-500BK	20.7 lbs (9.4 kg)
Environmental system						
Work environment	Suitable for Wet Locations, IP65/69K					
Operating temperature	-40°F to 140°F (-40°C to 60°C)					
L-70 Life	R > 54,000 hrs; C > 141,000 hrs					
Optical system						
Luminous flux	ASD-UHB5-PRO-100BK	16,639/17,580/16,814 lm	ASD-UHB5-PRO-200BK	31,963/33,575/32,325 lm	ASD-UHB5-HV-PRO-150BK	24,113/25,842/25,226 lm
	ASD-UHB5-PRO-150WH	24,716/26,331/25,554 lm	ASD-UHB5-PRO-240BK	37,848/40,557/39,704 lm	ASD-UHB5-HV-PRO-200BK	32,246/34,126/33,093 lm
	ASD-UHB5-PRO-150BK		ASD-UHB5-PRO-300BK	46,406/49,914/48,993 lm	ASD-UHB5-HV-PRO-240BK	38,715/41,331/40,467 lm
	ASD-UHB5-PRO-200WH	31,963/33,575/32,325 lm	ASD-UHB5-PRO-500BK	77,663/82,551/82,021 lm	ASD-UHB5-HV-PRO-300BK	47,792/51,514/50,365 lm
					ASD-UHB5-HV-PRO-500BK	77,512/82,905/81,254 lm
Color temperature	3CCT switch (3,000/4,000/5,000 K), 5,000 K by default					
CRI	> 70					
Electrical system						
Input voltage	Regular voltage: 120-277 V High voltage: 277-480 V					
Max input current	ASD-UHB5-PRO-100BK	1.6 A	ASD-UHB5-PRO-200BK	2.6 A	ASD-UHB5-HV-PRO-150BK	0.7 A
	ASD-UHB5-PRO-150WH	2 A	ASD-UHB5-PRO-240BK	3 A	ASD-UHB5-HV-PRO-200BK	1.06 A
	ASD-UHB5-PRO-150BK		ASD-UHB5-PRO-300BK	3.5 A	ASD-UHB5-HV-PRO-240BK	1.15 A
	ASD-UHB5-PRO-200WH	2.6 A	ASD-UHB5-PRO-500BK	5.8 A	ASD-UHB5-HV-PRO-300BK	1.8 A
Inrush current (Action time)	ASD-UHB5-PRO-100BK	80 A (0.35 S)	ASD-UHB5-PRO-200BK	80 A (0.35 S)	ASD-UHB5-HV-PRO-500BK	1.2 A
	ASD-UHB5-PRO-150WH		ASD-UHB5-PRO-240BK		ASD-UHB5-HV-PRO-150BK	120 A (0.36 S)
	ASD-UHB5-PRO-150BK		ASD-UHB5-PRO-300BK	ASD-UHB5-HV-PRO-200BK	90 A (0.36 S)	
	ASD-UHB5-PRO-200WH		ASD-UHB5-PRO-500BK	ASD-UHB5-HV-PRO-240BK	90 A (0.25 S)	
				ASD-UHB5-PRO-500BK	ASD-UHB5-HV-PRO-300BK	90 A (0.31 S)
			ASD-UHB5-HV-PRO-500BK	450 A (0.5 S)		
Off state power	0W					
Power consumption	ASD-UHB5-PRO-100BK	60/80/100W	ASD-UHB5-PRO-200BK	100/150/200W	ASD-UHB5-HV-PRO-150BK	100/120/150W
	ASD-UHB5-PRO-150WH	100/120/150W	ASD-UHB5-PRO-240BK	150/200/240W	ASD-UHB5-HV-PRO-200BK	100/150/200W
	ASD-UHB5-PRO-150BK		ASD-UHB5-PRO-300BK	200/240/300W	ASD-UHB5-HV-PRO-240BK	150/200/240W
	ASD-UHB5-PRO-200WH	100/150/200W	ASD-UHB5-PRO-500BK	300/400/500W	ASD-UHB5-HV-PRO-300BK	200/240/300W
				ASD-UHB5-HV-PRO-500BK	300/400/500W	
Power factor	> 0.9					
Output voltage	180-260 V	for ASD-UHB5-PRO-500BK model: 114-228 V				
Max output current	ASD-UHB5-PRO-100BK	0.3-0.5 A	ASD-UHB5-PRO-200BK	0.5-0.83 A	ASD-UHB5-HV-PRO-150BK	0.3-0.75 A
	ASD-UHB5-PRO-150WH	0.37-0.62 A	ASD-UHB5-PRO-240BK	0.6-1 A	ASD-UHB5-HV-PRO-200BK	0.46-1 A
	ASD-UHB5-PRO-150BK		ASD-UHB5-PRO-300BK	1.1-1.5 A	ASD-UHB5-HV-PRO-240BK	0.57-1.2 A
	ASD-UHB5-PRO-200WH	0.5-0.83 A	ASD-UHB5-PRO-500BK	1.4-2.8 A	ASD-UHB5-HV-PRO-300BK	0.77-1.5 A
				ASD-UHB5-HV-PRO-500BK	0.75-1.1 A	
Surge protection DM/CM	6 kV / 6 kV					
Dimming compatible controls						
Brand	Lutron		Leviton			
Models	DVSTV-453P		IP710-LFZ			
Regular and voluntary certifications						
5-year limited warranty						
DesignLights Consortium (DLC) listed (classification: Premium)						
UL listed E473804						

PACKAGE CONTENTS:

Description	Q-ty
LED UFO High Bay with Q-Base	1
Mounting ring (A)	1
Box	1









For most up-to-date spec sheets please refer to asd-lighting.com

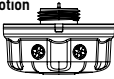
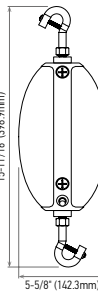
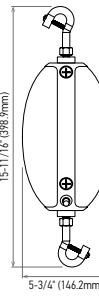
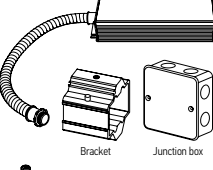
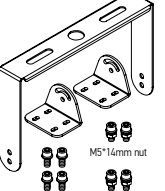
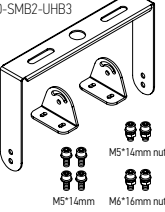
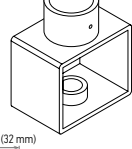
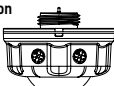

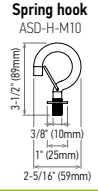
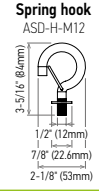
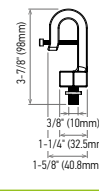
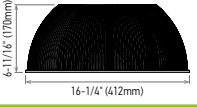
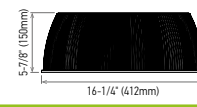
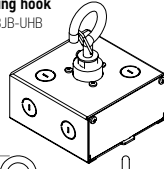
LED UFO HIGH BAY WITH Q-BASE

ACCESSORIES (sold separately):

Microwave motion sensor 3pin ASD-09MW 	Battery back-up kit 40W BLD-RM40R  15-11/16" (398.9mm) 5-5/8" (142.3mm)	Battery back-up kit 60W BLD-RM60R  15-11/16" (398.9mm) 5-3/4" (146.2mm)	Battery back-up kit 60W for 277-480V BLD-GM60R-HV  Bracket Junction box M5*7mm M5*14mm M5*16mm Ring G-hook Wiring cap Remote test switch for battery back-up kit RN1	Surface mount bracket ASD-SMB1-UHB3  M5*14mm nut M5*14mm M6*16mm nut M5*14mm M6*16mm nut 6-11/16" (170mm) 2-5/8" (67mm) 10-1/16" (256mm)	ASD-SMB2-UHB3  M5*14mm nut M5*14mm M6*16mm nut 8-1/8" (210.2mm) 2-5/8" (67mm) 12-5/16" (313.6mm)	Pendant mount bracket ASD-PMB-UHB  M5*11mm M10 M12 1-1/4" (32mm) 2-7/8" (72mm) 1-15/16" (50mm) 1-5/8" (40mm) Inner thread 3/4"-14 NPT M3 internal thread 1/2" (13mm) 2-3/8" (60mm)	
Infrared motion sensor 3pin ASD-09IR 	Remote test switch for battery back-up kit RN1 	Spring hook ASD-H-M10  3-1/2" (89mm) 3/8" (10mm) 1" (25mm) 2-5/16" (59mm)	Spring hook ASD-H-M12  3-5/16" (64mm) 1/2" (12mm) 7/8" (22.6mm) 2-1/8" (53mm)	Screw-bolt hook ASD-HS-M10  3-7/8" (98mm) 3/8" (10mm) 1-1/4" (32.5mm) 1-5/8" (40.8mm)	Polycarbonate reflector 16" 90° ASD-DUHB5A-16PC  6-11/16" (170mm) 16-1/4" (412mm)	ASD-DUHB5B-16PC  5-7/8" (150mm) 16-1/4" (412mm)	Pendant mount bracket with j-box and spring hook ASD-PMBJB-UHB  M10 M12 7-3/16" (183mm) 4-3/4" (120mm) 5-1/16" (128mm)
Remote control for motion sensor ASD-06RC  Remote control for motion sensor smart ASD-06RC-NLS 	Polycarbonate bottom conical lens ASD-BLUHB5AB  1-9/16" (40mm) 15-15/16" (405mm)						

ACCESSORY COMPATIBILITY LIST:

Models	Accessories																
	Microwave motion sensor 3pin ASD-09MW-WH ASD-09MW-BK	Infrared motion sensor 3pin ASD-09IR-WH ASD-09IR-BK	Microwave motion sensor smart 3pin ASD-09MW-NLS-WH	Infrared motion sensor smart 3pin ASD-09IR-NLS-WH	Battery back-up kit 40W BLD-RM40R	Battery back-up kit 60W BLD-RM60R	Battery back-up kit 60W for 277-480V BLD-GM60R-HV	Spring hook M10 ASD-H-M10	Spring hook M12 ASD-H-M12	Screw-bolt hook M10 ASD-HS-M10	Pendant mount bracket ASD-PMB-UHB	Pendant mount bracket with j-box and spring hook ASD-PMBJB-UHB	Surface mount bracket ASD-SMB1-UHB3-WH ASD-SMB1-UHB3-BK	Surface mount bracket ASD-SMB2-UHB3-BK	Polycarbonate bottom lens ASD-BLUHB5AB	Polycarbonate reflector 16" 90° ASD-DUHB5A-16PC	Polycarbonate reflector 16" 90° ASD-DUHB5B-16PC
ASD-UHB5-PRO-100BK	•	•	•	•	•	•	•	•	•	•	•	•	•	•	•	•	•
ASD-UHB5-PRO-150WH	•	•	•	•	•	•	•	•	•	•	•	•	•	•	•	•	•
ASD-UHB5-PRO-150BK	•	•	•	•	•	•	•	•	•	•	•	•	•	•	•	•	•
ASD-UHB5-PRO-200WH	•	•	•	•	•	•	•	•	•	•	•	•	•	•	•	•	•
ASD-UHB5-PRO-200BK	•	•	•	•	•	•	•	•	•	•	•	•	•	•	•	•	•
ASD-UHB5-PRO-240BK	•	•	•	•	•	•	•	•	•	•	•	•	•	•	•	•	•
ASD-UHB5-PRO-300BK	•	•	•	•	•	•	•	•	•	•	•	•	•	•	•	•	•
ASD-UHB5-PRO-500BK	•	•	•	•	•	•	•	•	•	•	•	•	•	•	•	•	•
ASD-UHB5-HV-PRO-150BK	•	•	•	•	•	•	•	•	•	•	•	•	•	•	•	•	•
ASD-UHB5-HV-PRO-200BK	•	•	•	•	•	•	•	•	•	•	•	•	•	•	•	•	•
ASD-UHB5-HV-PRO-240BK	•	•	•	•	•	•	•	•	•	•	•	•	•	•	•	•	•
ASD-UHB5-HV-PRO-300BK	•	•	•	•	•	•	•	•	•	•	•	•	•	•	•	•	•
ASD-UHB5-HV-PRO-500BK	•	•	•	•	•	•	•	•	•	•	•	•	•	•	•	•	•

For most up-to-date spec sheets please refer to asd-lighting.com



LED UFO HIGH BAY WITH Q-BASE

MOTION SENSOR INFORMATION

REMOTE CONTROL **ASD-06RC** **ASD-06RC-NLS** sold separately:

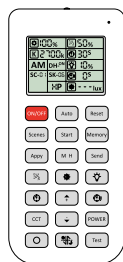

Button	Remarks	Button	Remarks	Button	Remarks
ON/OFF	ON/OFF Turn the sensor ON/OFF.	M H	Mounting height Adjust detection area/sensitivity levels according to real installation situations, higher or lower.	↑	Up The main functional buttons to adjust the factors to desired level.
Auto	Auto Enter "sensor mode" and perform previous settings.	Send	Send Memorize and send out the previous setting of individual parameters.	↓	Down Press + - button to dim light directly in non-detection mode.
Reset	Reset Enter "sensor mode" and perform the default settings.	↻	Detection range Also known as "sensitivity", 100 % means the highest sensitivity and longest distance. Use this button and the + - buttons to adjust.	CCT	CCT Selectable Not applicable to this product.
Scenes	Scenes Shows current settings saved in remote.	☀	Daylight sensor The preset lux level at which motion will be detected. Use this button and the + - buttons to adjust.	POWER	Power Adjust brightness in both ON/OFF mode & sensor mode, minimum 10%, max 100%, each time this button is pressed it changes by 5%.
Start	Start Press this to begin scene setup.	⏸	Stand-by dimming After hold time, the light will dim from 100 % to optional standby dimming levels. Use this button and the + - buttons to adjust.	○	Reserved Button Not applicable to this product.
Memory	Memory Saves the scene settings.	⌚	Hold time The period that light will stay illuminated 100 % after no motion is detected. Use this button and the + - buttons to adjust.	☀	Daylight Harvesting Daylight harvesting function enabled or disabled.
Apply	Apply Applies current scene settings to the fixture.	⌚	Stand-by period The period after holdtime, during which the light keeps standby dimming level. Use this button and the + - buttons to adjust.	Test	Test button Press this button to test the sensor; it will temporarily change the hold time to 2s. This setting cannot be saved.

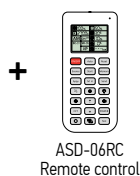
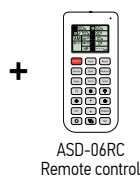

ASD-09MW, ASD-09MW-NLS:

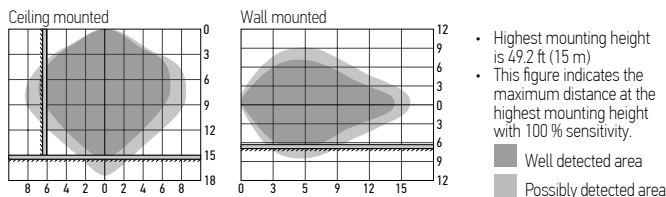

User notes:

1. Microwaves can penetrate walls or glass thinner than 0.8" but will be impaired if thicker than 0.8".
2. The driver voltage shall be stable and float within 10%.
3. Detection area will be affected by speed of motion, mounting height and movement volume.
4. Conduct testing with adequate ambient lighting for best results.
5. Dimming performance differs when connected to different drivers; If the driver can't completely turn OFF, sensor can't either.
6. The first time powered ON sensor, light will be ON 100% for about 10S then dims to standby level or OFF.

Installation precautions:

1. Suitable for ceiling mount installation, adjust sensitivity properly if it's installed on side-wall because it gets more sensitive.
2. Make sure the microwave module is completely exposed.
3. The detection surface of the sensor module should be installed facing the detection area.

Application environment:

1. Suitable for indoor application, half/completely outdoor environment conditions might trigger the sensor.
2. Shall be mounted securely, to avoid any false triggers caused by movement of the fixture itself.
3. Keep the sensor module away from AC input and DC output to avoid high/low frequency signal interference.

Specifications	Models: ASD-09MW, ASD-09MW-NLS	Models: ASD-09IR, ASD-09IR-NLS
Operating voltage	10-15 V	
Operating current	< 30 mA	< 15 mA
Detection area	25 %/50 %/75 %/100 %	
Hold time	Remote control: 5 s/30 s/1 min/3 min/5 min/10 min/20 min/30 min Built-in switch: 5 s/1 min/5 min/10 min	
Daylight threshold	2 lux (0.2 fc)/10 lux (0.9 fc)/30 lux (2.8 fc)/50 lux (4.7 fc)/80 lux (7.4 fc)/120 lux (11.2 fc)/200 lux (18.6 fc)/250 lux (23.2 fc)/ 300 lux (27.9 fc)/350 lux (32.5 fc)/400 lux (37.2 fc)/disable	
Standby period	0 s/10 s/30 s/1 min/5 min/10 min/30 min/60 min/+ ∞	
Standby dimming level	Remote control: 10 %/20 %/30 %/50 % Built-in switch: 0 %/10 %/30 %/50 %	
Mounting height	max 49.2 ft (15 m)	≤ 39.4 ft (12 m)
Detection range	≥ 9 ft (3 m)	
Operating frequency	5.8 GHz ± 75 GHz	-
Transmitting power	< 0.3 mW	-

ASD-09IR, ASD-09IR-NLS:

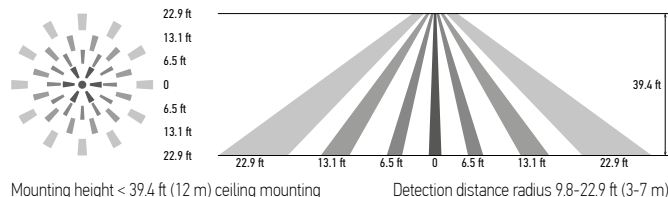

User notes:

1. The driver voltage shall be stable and float within 10%.
2. Detection area options may NOT working obviously because it works depends on fresnel lens, it's physically defined.
3. Detection distance performance works better when moving parallel to the sensor as opposed to towards it.
4. Conduct testing with adequate ambient lighting for best results.
5. Dimming performance differs when connected to different drivers; If the driver can't completely turn OFF, sensor can't either.
6. The first time powering ON the sensor, light will be ON 100% for about 45S then dims to standby level or OFF.

Installation precautions:

1. PIR sensor can't be placed inside any material, fresnel lens must be completely exposed in air.
2. Fresnel lens of the PIR sensor must be lower than light fixture.
3. Suitable for ceiling mount installation, adjust sensitivity properly if it's installed on a wall because it will become more sensitive.

Application environment:

1. Suitable for indoor application, half/completely outdoor environment conditions might trigger the sensor.
2. Not suitable environment if there's sudden changed temperature of airflow for PIR sensor.
3. Not suitable environment if there's shelves between the sensor and target area.
4. Shall be mounted securely, to avoid any false triggers caused by movement of the fixture itself.

DEFAULT SETTING:

Specifications	
Detection area	100 %
Hold time	10 min
Daylight threshold	Disable
Stand-by period	0 s
Stand-by dimming level	10 %

For most up-to-date spec sheets please refer to asd-lighting.com



LED UFO HIGH BAY WITH Q-BASE

WITH DUSK/DAWN FUNCTION:

1. With insufficient ambient brightness, sensor turns on light and keeps it at standby dimming level even if there is no motion or presence.
2. When sensor detects motion or presence it will bring the light level up to 100%.
3. After motion is no longer detected, fixture remains at 100% for hold time.
4. After pre-set hold time period it will dim to standby dimming level again and always keep it.
5. With sufficient ambient brightness, sensor will turn OFF light automatically.

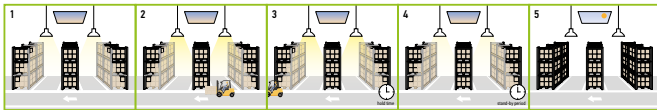

WITH DAYLIGHT DISABLED:

1. Sensor turns ON light when motion is detected.
2. Light will stay on after detecting motion for the desired hold time.
3. Sensor dims light to standby dimming level after hold time if there is still no motion.
4. Sensor turns OFF light after standby period.

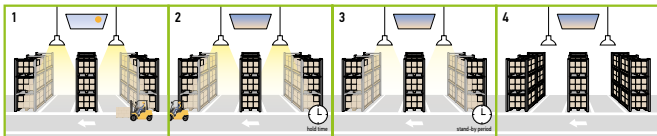

WITH DAYLIGHT THRESHOLD:

1. With sufficient daylight, the light remains OFF even after motion is detected.
2. With insufficient daylight, the sensor turns light ON when motion is detected.
3. After there's no motion detected, the sensor keeps light ON 100% for holdtime.
4. After holdtime, sensor dims light to standby dimming level for standby period. If the standby period has been set as 0s, sensor turns light OFF automatically after holdtime.
5. The sensor turns OFF light automatically after the standby period when there's no motion detected.

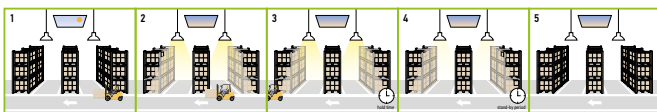

DAYLIGHT HARVESTING:

1. When ambient brightness is lower than preset lux level, sensor will turn on light automatically and keep dimming according to the change of the ambient brightness. As it gets darker outside the fixtures will brighten, and as it gets brighter outside the fixtures will dim down.
2. When the ambient brightness exceeds the preset lux level, the light will turn OFF.

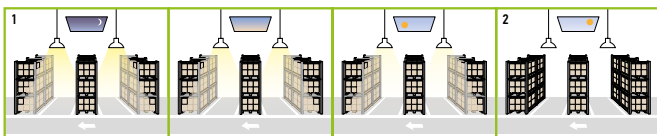

MICROWAVE MOTION SENSOR:

To avoid blocking the microwave emission, the microwave sensor can not be covered with metal materials, be sprayed with a coating of metal components, or have attached metal material or stickers etc.

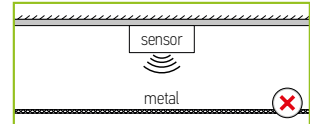

The distance between the antenna and the glass (dielectric material) should be no less than 0.4 ft when the sensor is within the glass lampshade. Otherwise, the microwave motion sensor will not penetrate the glass easily.

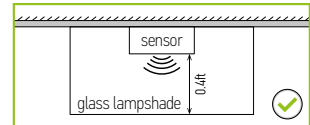

Avoid placing the sensor inside a metal chamber, this may cause a mis-trigger.

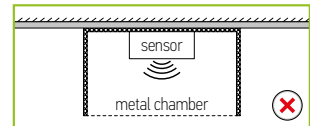

The sensor should not be placed in a small confined space. To avoid increasing the sensor detection range or abnormal operation, the sensor should be kept away from large areas of metal and glass reflectors (separation distance at least 3.3 ft). Reduce the detection area setting.

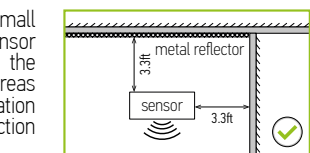

To avoid affecting the microwave signal transmission, the microwave antenna should be higher than the surrounding metal surface.

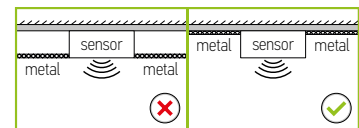

Any vibration or movement may trigger the sensor. Ensure the sensor is far from any constant movement.

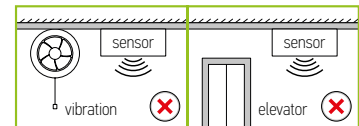

At least 2 m/6.5 ft distance between microwave sensors; 1.5 m/4.9 ft between the sensor and other wireless devices such as routers to avoid possible radio interference.

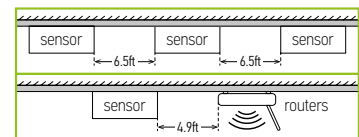

DAYLIGHT HARVESTING SETTING:

1. Adjust "daylight" value higher than 50lux.
2. Preset "standby period" 0S
3. Press MW/PIR button 3 times until the MW/PIR icons are both blinking on LCD screen, daylight harvesting function enabled. (With BLE version, press DH button, daylight harvesting function enabled).

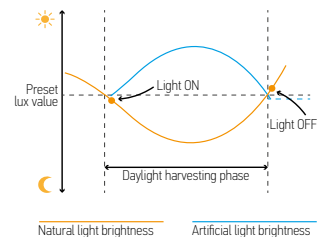



LED UFO HIGH BAY WITH Q-BASE

BATTERY BACK-UP KIT INFORMATION

BLD-RM40R BLD-RM60R sold separately:

BLD-RM40R, BLD-RM60R listed for field and factory installation, provides constant power output to the load during emergency mode operation. They maintain illumination in emergency mode for a minimum of 90 minutes. It is an ideal emergency solution for UFO LED highbay lights.

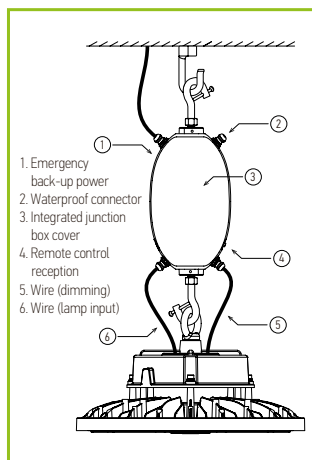

BLD-GM60R-HV sold separately:

BLD-GM60R-HV listed for field and factory installation, provides constant power output to the load during emergency mode operation. It maintains illumination in emergency mode for a minimum of 90 minutes. It is an ideal emergency solution for UFO LED highbay lights.

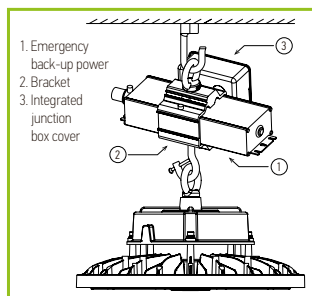
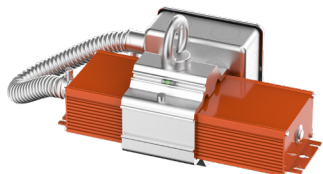

Specifications	BLD-RM40R	BLD-RM60R	BLD-GM60R-HV
Input voltage	100-347 V		277-480 V
Input current	≤ 200 mA		max 100 mA
Input power	max 15W		max 20W
Standby input power	< 0.8W (finished charging)		< 6W (finished charging)
Maximum standby time between recharges	6 months		
Driver type	Constant power		
Output power (emergency mode)	40W	60W	
Output voltage range	≤ 170 Vdc		400 Vdc
Lumens	6,000 lm		
Maximum load power	300W (when dimming to a minimum, the power needs to be less than 36W)		
Peak output power (emergency mode)	100W (lasts for 10 seconds)		65W
Number of output channels	1 channel		
RFI/EMI	FCC part 15 class B		
Output type	LED class 1		
Battery type	Li-ion		
Battery capacity available	2600 mAh (96 WH)		4000 mAh (115 WH)
Battery recharge time	24 hours		
Battery discharge time	90 min		
Maximum lighting fixture weight	44.1 lbs (20 kg)		44.1 lbs (20 kg)
Self-diagnostic test system	<p>In the normal charging mode, the system performs a self-diagnostic test every 30 days, the system switches to emergency mode for 30S, and then automatically switches back to the normal charging mode.</p> <p>In the normal charging mode, the system switches to emergency mode every 360 days (after 11 monthly self-diagnostic test) and works until the end of discharge. Automatically switches back to normal charging mode after discharge.</p>		
Operating temperature	-32°F to 122°F (0°C to 50°C)		40°F to 122°F (5°C to 50°C)
Service life	50,000 hours		
Input surge protection	2 kV		
Protections	Battery over discharge protection, output short circuit protection		
Approvals/class	RoHS, UL924 listed, CEC title 20 Dry/Wet Locations, IP65		

STANDARD OPERATION DISPLAY STATUS:

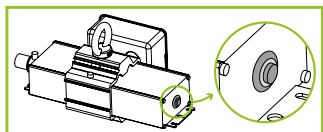

Charging	
Emergency mode	

AC operation: AC power is present. The AC driver operates the LED load as designed. The emergency driver is charging in standby mode. The charging indicator will be lit, showing that the battery is charging.

Emergency operation: When the AC power goes out, the emergency driver detects the AC power outage and automatically switches to emergency mode. When red LED light is OFF, that means driver is discharging. When the AC power is restored, the emergency driver goes back to AC power and starts recharging.

REMOTE TEST SWITCH

RN1 sold separately:

- ▶ Press the ON button to switch battery to the back-up mode. The indicator light will turn off and fixture will decrease light output.
- ▶ Press OFF to switch the fixture to normal operation mode.



For most up-to-date spec sheets please refer to asd-lighting.com



LED UFO HIGH BAY WITH Q-BASE

INSTALLATION GUIDE

IMPORTANT SAFETY INFORMATION:

Please read all the instructions below before installation.

- ▶ Make sure that the supply voltage corresponds to the rated product voltage.
- ▶ The product must be installed by a qualified electrician in accordance with the National Electrical Code and corresponding local codes.
- ▶ If the product is damaged, do not use it.

⚠ WARNING

RISK OF PERSONAL INJURY – READ and follow all WARNINGS and installation instructions. Keep or give to the owner for future reference.

Risk of cuts: Wear gloves to prevent cuts or abrasions when removing from carton, handling, installing, and maintaining this product.

Risk of electric shock: This product must be installed in accordance with the applicable installation code by a person familiar with the construction and operation of the product and the hazards involved.

Risk of Fire: Minimum 194°F supply conductors. Consult a qualified electrician to ensure correct branch circuit conductor.

ASD® assumes no responsibility for claims arising out of improper or careless Installation or handling of this product.

ELECTRICAL SCHEMATIC DIAGRAM:

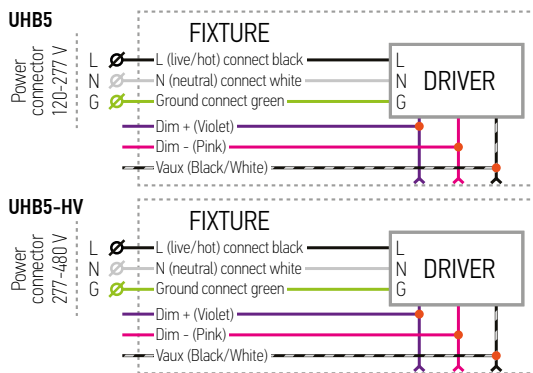

UHB5 with motion sensor

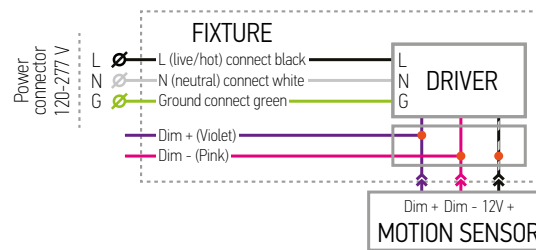

UHB5 with battery back-up kit

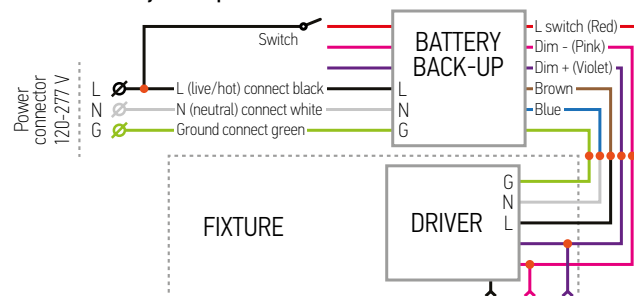

UHB5-HV with battery back-up kit

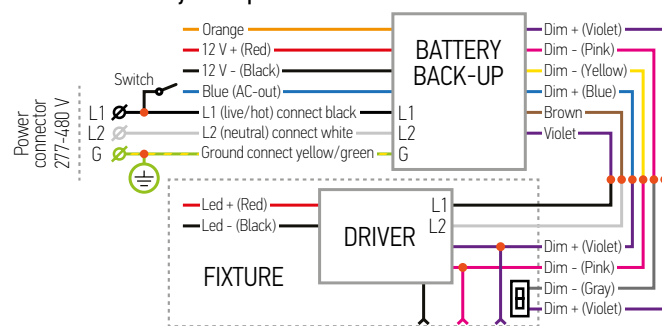

For most up-to-date spec sheets please refer to asd-lighting.com



LED UFO HIGH BAY WITH Q-BASE

INSTALLATION STEPS:

1. Screw on the mounting ring (included) and tighten it.
For 100-300W models unscrew the knock out on the driver box and adjust color temperature or/and power by simple switch.
For 500W models open rubber caps on the middle of the lens, take off caps inside and adjust color temperature or/and power by simple switch.
2. Clip the fixture on the hook in the ceiling using the mounting ring.
3. Connect the wires: Black to Black, White to White, Green to Green. Secure the connection with wire nuts.

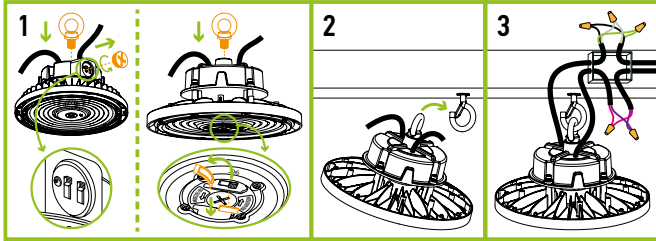

SURFACE MOUNT BRACKET INSTALLATION

ASD-SMB1-UHB3 **ASD-SMB2-UHB3**

sold separately:

1. Use four M5x9/16" screws (included) to install bracket swivel on the top of the fixture's body.
2. Use two M6x5/8" screws (included) to secure bracket on the swivels.
3. Adjust the light direction and secure it using two M5x9/16" screws with screw-nuts (included).

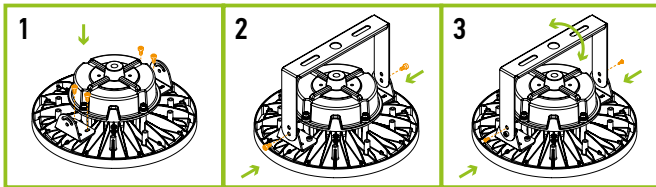

MOTION SENSOR INSTALLATION

ASD-09MW **ASD-09MW-NLS**

ASD-09IR **ASD-09IR-NLS**

sold separately:

1. Unscrew the microwave sensor base cap.
2. Insert and twist the sensor until it is tight on the base surface. FOR ASD-09-NLS sensors download ASD NLS APP using QR codes and add the fixture to it according to the manual.

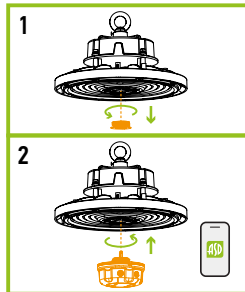

For ASD NLS sensors please download [link link](#) or QR-code below.



PENDANT MOUNT BRACKET INSTALLATION

ASD-PMB-UHB sold separately:

1. Remove the original ring from the driver.
2. Install the bracket and secure it to the driver using a M10 or M12 screw (included with the bracket).
3. Screw the bracket with the fixture onto a pole and secure it with an M3 screw (included with the bracket).

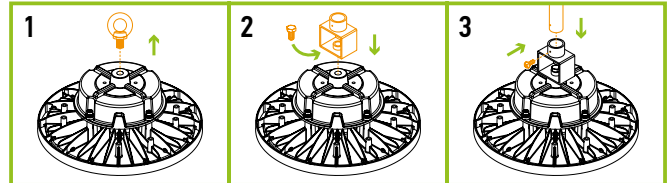

PENDANT MOUNT BRACKET WITH J-BOX AND SPRING HOOK INSTALLATION

ASD-PMBJB-UHB sold separately:

1. Uninstall the mounting ring from the fixture. Unscrew 2 screws and open the side plate on the Pendant Junction box. Install M10 or M12 Mounting screw depending of the fixture's thread size.
2. **Mounting hook installation:** Loosen security screw and install the spring hook into the upper installation hole of the Pendant J-box and secure it with screw. Secure Pendant J-box to the fixture, and then secure to the ceiling. Close and secure side plate back into place.
3. **Pendant installation:** Uninstall adapter from pole mounting hole. Secure the Pendant J-box and fixture to the pole. Secure fixture to the Pendant J-box. Close and secure side plate back into place.

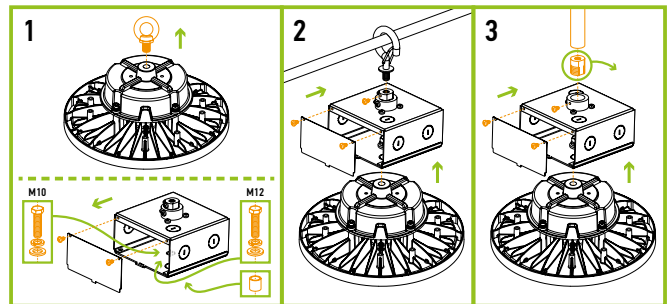

ASD NLS APP DOWNLOAD:

Android



IOS



For most up-to-date spec sheets please refer to asd-lighting.com

ASD LIGHTING CORP

E-mail: orders@asd-lighting.com | Web site: www.asd-lighting.com





LED UFO HIGH BAY WITH Q-BASE

BATTERY BACK-UP KIT INSTALLATION

BLD-RM40R **BLD-RM60R** sold separately:

1. Install the G-hook to the top thread hole of the battery back-up and secure with the screw. Attach the battery back-up with G-hook to the ceiling hook.
2. Loosen the screw on the enclosed hook on the bottom of the emergency back-up, attach the ring on the fixture to the hook and tighten screw back. Open the cover and remove the plastic covers and install the five waterproof connectors.
3. Pull all wires through the waterproof connectors into the chamber of emergency driver. Connect wires: Brown, Blue, Green with AC input wires of the fixture. Connect dimming wires Purple and Pink with LED driver input dimming wires. Connect Black, White and Red wires of the battery back-up with AC main Power cord. Secure connection with wire nuts and lock up the cover of junction box.

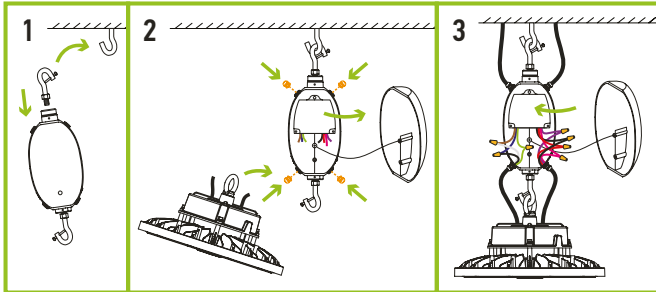

BATTERY BACK-UP KIT INSTALLATION

BLD-GM60R-HV sold separately:

1. Insert battery back-up into the bracket and secure it with three screws. Attach junction box to the side of the bracket with two screws. Screw in mounting ring to the top and mounting hook to the bottom of the bracket. Secure them at a 45° angle.
2. Attach bracket with battery to the ceiling using mounting ring. Attach lighting fixture to the mounting hook on the bottom of the bracket and secure it with screw.
3. Plug the fixture's power cable and circuit cable into the junction box. Wire according to the wiring diagram inside the junction box. Close junction box with cover and secure it with two screws.

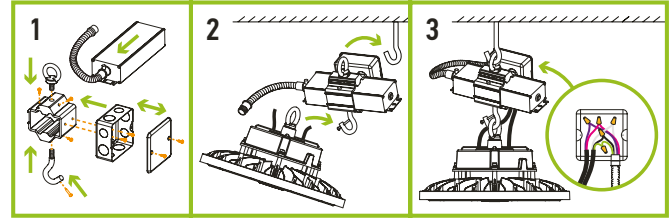

DIFFUSER AND LENS INSTALLATION

ASD-DUHB5A-16PC **ASD-DUHB5B-16PC**

ASD-BLUHB5AB sold separately:

1. Install the diffuser, tighten the screws.
2. Attach the conical lens to the included clamp.

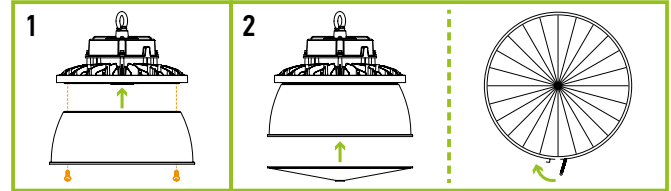

For most up-to-date spec sheets please refer to asd-lighting.com



LED UFO HIGH BAY WITH Q-BASE

ORDERING INFORMATION

Model	UPC	Pcs. per carton	Carton size	Carton weight	GTIN 14
UHB5-PRO					
ASD-UHB5-PRO-100BK	810128113564	1	9.7' x 9.7' x 5.3'	4.8 lbs	-
ASD-UHB5-PRO-150WH	810128114813	1	9.7' x 9.7' x 5.3'	5 lbs	-
ASD-UHB5-PRO-150BK	810128113571	1	9.7' x 9.7' x 5.3'	5 lbs	-
ASD-UHB5-PRO-200WH	810128114806	1	12.8' x 12.8' x 6.1'	7.2 lbs	-
ASD-UHB5-PRO-200BK	810128113588	1	12.8' x 12.8' x 6.1'	7.2 lbs	-
ASD-UHB5-PRO-240BK	810128113595	1	12.8' x 12.8' x 6.1'	7.2 lbs	-
ASD-UHB5-PRO-300BK	810128113601	1	13.6' x 13.6' x 6.5'	8 lbs	-
ASD-UHB5-PRO-500BK	810128113618	1	18.7' x 18.7' x 8.4'	20.3 lbs	-
UHB5-HV-PRO HIGH VOLTAGE					
ASD-UHB5-HV-PRO-150BK	810128113519	1	9.7' x 9.7' x 5.3'	5.9 lbs	-
ASD-UHB5-HV-PRO-200BK	810128113526	1	12.8' x 12.8' x 6.1'	7.5 lbs	-
ASD-UHB5-HV-PRO-240BK	810128113533	1	12.8' x 12.8' x 6.1'	7.5 lbs	-
ASD-UHB5-HV-PRO-300BK	810128113540	1	13.6' x 13.6' x 6.5'	8.4 lbs	-
ASD-UHB5-HV-PRO-500BK	810128113557	1	18.7' x 18.7' x 9.5'	23.1 lbs	-

ACCESSORIES:

Model	Description	UPC	Pcs. in middle box	Middle box size	Middle box weight	GTIN 14 in middle box	Pcs. per carton	Carton size	Carton weight	GTIN 14
ASD-09MW-WH	Microwave motion sensor 3pin white	810128113700	10	5.5' x 2.6' x 11.4'	1.2 lbs	20810128113704	120	17.3' x 11.8' x 11'	12.1 lbs	30810128113701
ASD-09MW-BK	Microwave motion sensor 3pin black	810128113717	10	5.5' x 2.6' x 11.4'	1.2 lbs	20810128113711	120	17.3' x 11.8' x 11'	12.1 lbs	30810128113718
ASD-09IR-WH	Infrared motion sensor 3pin white	810128113694	10	5.5' x 2.6' x 11.4'	1.2 lbs	20810128113698	120	17.3' x 11.8' x 11'	12.1 lbs	30810128113695
ASD-09IR-BK	Infrared motion sensor 3pin black	810128114349	10	5.5' x 2.6' x 11.4'	1.2 lbs	20810128114343	120	17.3' x 11.8' x 11'	12.1 lbs	30810128114340
ASD-06RC	Remote control for motion sensor	810128114370	10	6.3' x 2.9' x 11.4'	0.5 lbs	30810128114371	60	15.8' x 11.8' x 9.3'	24.7 lbs	40810128114378
ASD-09MW-NLS-WH	Microwave motion sensor smart 3pin white	810128113762	10	5.5' x 2.6' x 11.4'	1.2 lbs	20810128113766	120	17.3' x 11.8' x 11'	12.1 lbs	30810128113763
ASD-09IR-NLS-WH	Infrared motion sensor smart 3pin white	810128113755	10	5.5' x 2.6' x 11.4'	1.2 lbs	20810128113759	120	17.3' x 11.8' x 11'	12.1 lbs	30810128113756
ASD-06RC-NLS	Remote control for motion sensor smart	810128114387	10	6.3' x 2.9' x 11.4'	0.5 lbs	20810128114381	60	15.8' x 11.8' x 9.3'	24.7 lbs	30810128114388
BLD-RM40R	Battery back-up kit 40W	810050738507	-	-	-	-	4	23.6' x 13.8' x 7.9'	32.5 lbs	20810050738501
BLD-RM60R	Battery back-up kit 60W	810128112154	-	-	-	-	4	23.6' x 13.8' x 7.9'	37.7 lbs	20810128112158
BLD-GM60R-HV	Battery back-up kit 60W for 277-480V	810128112147	-	-	-	-	5	20.5' x 10.8' x 16.7'	41.9 lbs	10810128112144
RN1	Remote test switch for battery back-up kit	810050735223	-	-	-	-	50	13' x 9.8' x 6.5'	8.3 lbs	20810050735227
ASD-H-M10	Spring hook M10	819201025312	-	-	-	-	50	12.6' x 7.7' x 6.9'	12.1 lbs	20819201025316
ASD-H-M12	Spring hook M12	810050730556	-	-	-	-	50	12.6' x 7.7' x 6.9'	17.6 lbs	10810050730553
ASD-HS-M10	Screw-bolt hook M10	810050731164	-	-	-	-	50	11.9' x 8.3' x 9.1'	12.6 lbs	10810050731161
ASD-PMB-UHB	Pendant mount bracket	810050731522	-	-	-	-	50	13.9' x 9.7' x 7.1'	33.7 lbs	10810050731529
ASD-PMBJB-UHB	Pendant mount bracket with J-box and spring hook	810050736992	-	-	-	-	20	17.2' x 11.3' x 11.2'	30.9 lbs	10810050736999
ASD-SMB1-UHB3-WH	Surface mount bracket white for 100-300W	810128111652	-	-	-	-	20	22.1' x 14.6' x 16.5'	32 lbs	10810128111659
ASD-SMB1-UHB3-BK	Surface mount bracket black for 100-300W	810050739818	-	-	-	-	20	22.1' x 14.6' x 16.5'	32 lbs	10810050739815
ASD-SMB2-UHB3-BK	Surface mount bracket black for 400-500W	810128110785	-	-	-	-	20	26' x 17.7' x 15.4'	59.5 lbs	10810128110782
ASD-BLUHB5AB	Polycarbonate bottom lens	810128114448	-	-	-	-	10	18.5' x 18.5' x 7.1'	9.3 lbs	10810128114445
ASD-DUHB5A-16PC	Polycarbonate reflector 16' 90° for 100-150W	810128114424	-	-	-	-	10	18.5' x 18.5' x 21.7'	14.8 lbs	10810128114421
ASD-DUHB5B-16PC	Polycarbonate reflector 16' 90° for 200-240W	810128114431	-	-	-	-	10	18.5' x 18.5' x 19.3'	17.6 lbs	10810128114438

For most up-to-date spec sheets please refer to asd-lighting.com



LED UFO HIGH BAY WITH Q-BASE

ANNEX 1

Model	Watts	3,000 K	4,000 K	5,000 K
ASD-UHB5-PRO-100BK	60W	10,533 lm	11,005 lm	10,797 lm
	80W	13,627 lm	14,310 lm	13,781 lm
	100W	16,639 lm	17,580 lm	16,814 lm
ASD-UHB5-PRO-150WH ASD-UHB5-PRO-150BK	100W	17,006 lm	18,083 lm	18,017 lm
	120W	20,221 lm	21,500 lm	20,930 lm
	150W	24,716 lm	26,331 lm	25,554 lm
ASD-UHB5-PRO-200WH ASD-UHB5-PRO-200BK	100W	16,677 lm	17,161 lm	17,234 lm
	150W	25,361 lm	26,446 lm	25,612 lm
	200W	31,963 lm	33,575 lm	32,325 lm
ASD-UHB5-PRO-240BK	150W	25,690 lm	27,225 lm	27,186 lm
	200W	32,852 lm	34,899 lm	34,133 lm
	240W	37,848 lm	40,557 lm	39,704 lm
ASD-UHB5-PRO-300BK	200W	34,263 lm	36,152 lm	35,848 lm
	240W	38,621 lm	41,235 lm	40,862 lm
	300W	46,406 lm	49,914 lm	48,993 lm
ASD-UHB5-PRO-500BK	300W	51,487 lm	53,485 lm	53,691 lm
	400W	65,394 lm	69,254 lm	69,507 lm
	500W	77,663 lm	82,551 lm	82,021 lm
ASD-UHB5-HV-PRO-150BK	100W	17,289 lm	18,332 lm	18,246 lm
	120W	20,509 lm	21,757 lm	21,293 lm
	150W	24,113 lm	25,842 lm	25,226 lm
ASD-UHB5-HV-PRO-200BK	100W	17,044 lm	17,668 lm	17,721 lm
	150W	25,158 lm	26,229 lm	25,611 lm
	200W	32,246 lm	34,126 lm	33,092 lm
ASD-UHB5-HV-PRO-240BK	150W	25,688 lm	27,079 lm	27,125 lm
	200W	33,252 lm	35,183 lm	34,472 lm
	240W	38,714 lm	41,331 lm	40,467 lm
ASD-UHB5-HV-PRO-300BK	200W	35,374 lm	37,704 lm	37,572 lm
	240W	41,191 lm	43,925 lm	43,126 lm
	300W	47,792 lm	51,514 lm	50,365 lm
ASD-UHB5-HV-PRO-500BK	300W	51,789 lm	54,021 lm	53,393 lm
	400W	68,164 lm	71,863 lm	70,393 lm
	500W	77,512 lm	82,905 lm	81,255 lm

For most up-to-date spec sheets please refer to asd-lighting.com