



# LED COMMERCIAL DOWNLIGHT

► **DESIGN** - LED COMMERCIAL DOWNLIGHT comes with a durable aluminum housing resistant to rust and impact, anti-glare PC lens, spring-loaded clips and 1.6 ft cord in metal hose. It is designed to operate on 120-277V circuits with a 0-10V dimmable driver.

► **COLOR AND POWER SELECTABLE** - You can choose either a 2,700K soft white, 3,000K warm white, 3,500K neutral white, 4,000K cool white, or 5,000K daylight color temperature, and change the power with a simple switch.

► **CRI90+** - rating provides rich and natural colors and keeps your space looking and feeling vibrant. True bright colors also improve your mood and general health.

► **INSTALLATION** - This fixture is IC rated so there is no can or any other housing required. It is also Wet Locations rated, making it perfect for any spaces with humidity requirements. Perfect for retail, hospitality, or any other commercial space with a high ceiling.

► **ADVANTAGES** - With a lifespan of 50,000 hours, these fixtures are made to last decades under normal operation! ASD provides a 5-year limited warranty along with UL and Energy Star certifications to guarantee top quality products and safety!

Catalog number	
Notes	
Type	

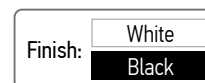

Model	Size	Watts	Voltage	Dimmable	Lumens	CCT	IC rated	Finish	Dimensions (DxH)	Cord
<b>DOWNLIGHTS CDL7</b>										
ASD-CDL7-4DA13AC	4 inch	7/10/13W	120-277 V	0-10 V	600/850/1,050 lm	5CCT (2,700/3,000/3,500/4,000/5,000 K)	Yes	White	5-3/8" x 3-1/16"	1.6 ft
ASD-CDL7-6DA22AC	6 inch	10/15/22W	120-277 V	0-10 V	900/1,300/1,850 lm	5CCT (2,700/3,000/3,500/4,000/5,000 K)	Yes	White	8-1/4" x 4"	1.6 ft
ASD-CDL7-6DA22AC-BK	6 inch	10/15/22W	120-277 V	0-10 V	900/1,300/1,850 lm	5CCT (2,700/3,000/3,500/4,000/5,000 K)	Yes	Black	8-1/4" x 4"	1.6 ft
ASD-CDL7-6DA30AC	6 inch	20/25/30W	120-277 V	0-10 V	1,830/2,161/2,487 lm	5CCT (2,700/3,000/3,500/4,000/5,000 K)	-	White	8-1/4" x 4"	1.6 ft
ASD-CDL7-8DA30AC	8 inch	12/20/30W	120-277 V	0-10 V	1,050/1,700/2,400 lm	5CCT (2,700/3,000/3,500/4,000/5,000 K)	Yes	White	10-1/4" x 4-7/16"	1.6 ft
ASD-CDL7-8DA30AC-BK	8 inch	12/20/30W	120-277 V	0-10 V	1,050/1,700/2,400 lm	5CCT (2,700/3,000/3,500/4,000/5,000 K)	Yes	Black	10-1/4" x 4-7/16"	1.6 ft
ASD-CDL7-8DA40AC	8 inch	30/35/40W	120-277 V	0-10 V	2,603/2,981/3,250 lm	5CCT (2,700/3,000/3,500/4,000/5,000 K)	-	White	10-1/4" x 4-7/16"	1.6 ft
ASD-CDL7-10DA40AC	10 inch	20/30/40W	120-277 V	0-10 V	1,800/2,400/3,000 lm	5CCT (2,700/3,000/3,500/4,000/5,000 K)	Yes	White	11-5/16" x 4-15/16"	1.6 ft
ASD-CDL7-10DA40AC-BK	10 inch	20/30/40W	120-277 V	0-10 V	1,800/2,400/3,000 lm	5CCT (2,700/3,000/3,500/4,000/5,000 K)	Yes	Black	11-5/16" x 4-15/16"	1.6 ft
ASD-CDL7-10DA60AC	10 inch	40/50/60W	120-277 V	0-10 V	3,477/4,148/4,903 lm	5CCT (2,700/3,000/3,500/4,000/5,000 K)	-	White	11-5/16" x 4-15/16"	1.6 ft
<b>DOWNLIGHT CDL7R 120lm/W</b>										
ASD-CDL7R-6A30WH	6 inch	12/16/22/26/30W	120-277 V	0-10 V	3,018/3,119/3,242/3,304/3,352 lm	5CCT (2,700/3,000/3,500/4,000/5,000 K)	Yes	White	8-3/8" x 4-13/16"	1.5 ft
ASD-CDL7R-8A35WH	8 inch	16/22/26/30/35W	120-277 V	0-10 V	3,838/3,935/4,093/4,178/4,246 lm	5CCT (2,700/3,000/3,500/4,000/5,000 K)	Yes	White	10-5/16" x 5-5/16"	1.5 ft
ASD-CDL7R-10A40WH	10 inch	22/26/30/35/40W	120-277 V	0-10 V	4,363/4,487/4,659/4,736/4,791 lm	5CCT (2,700/3,000/3,500/4,000/5,000 K)	Yes	White	11-9/16" x 5-15/16"	1.5 ft

For most up-to-date spec sheets please refer to [asd-lighting.com](http://asd-lighting.com)

ASD LIGHTING CORP

E-mail: [orders@asd-lighting.com](mailto:orders@asd-lighting.com) | Web site: [www.asd-lighting.com](http://www.asd-lighting.com)





# LED COMMERCIAL DOWNLIGHT

## PRODUCT SPECIFICATIONS:

Construction & Materials				
Housing	Aluminum			
Lens	PC			
Finish	White, Black			
Weight	ASD-CDL7-4DA13AC	0.7 lbs (0.3 kg)	ASD-CDL7R-8A35WH	1.5 lbs (0.7 kg)
	ASD-CDL7-6DA22AC	1.5 lbs (0.7 kg)	ASD-CDL7-8DA40AC	1.8 lbs (0.8 kg)
	ASD-CDL7-6DA22AC-BK		ASD-CDL7-10DA40AC	2.4 lbs (1.1 kg)
	ASD-CDL7-6DA30AC	1.2 lbs (0.5 kg)	ASD-CDL7-10DA40AC-BK	1.8 lbs (0.8 kg)
	ASD-CDL7R-6A30WH		ASD-CDL7R-10A40WH	2.4 lbs (1.1 kg)
	ASD-CDL7-8DA30AC	1.8 lbs (0.8 kg)	ASD-CDL7-10DA60AC	
ASD-CDL7-8DA30AC-BK				
Environmental system				
Work environment	Suitable for Wet Locations			
Operating temperature	-13°F to 113°F (-25°C to 45°C)		for CDL7R models: -4°F to 104°F (-20°C to 40°C)	
L-70 Life	> 50,000 hrs			
Optical system				
Luminous flux	ASD-CDL7-4DA13AC	600/850/1,050 lm	ASD-CDL7R-8A35WH	3,838/3,935/4,093/4,178/4,246 lm
	ASD-CDL7-6DA22AC	900/1,300/1,850 lm	ASD-CDL7-8DA40AC	2,603/2,981/3,250 lm
	ASD-CDL7-6DA22AC-BK		ASD-CDL7-10DA40AC	1,800/2,400/3,000 lm
	ASD-CDL7-6DA30AC	1,830/2,161/2,487 lm	ASD-CDL7-10DA40AC-BK	
	ASD-CDL7R-6A30WH	3,018/3,119/3,242/3,304/3,352 lm	ASD-CDL7R-10A40WH	4,363/4,487/4,659/4,736/4,791 lm
	ASD-CDL7-8DA30AC	1,050/1,700/2,400 lm	ASD-CDL7-10DA60AC	3,477/4,148/4,903 lm
ASD-CDL7-8DA30AC-BK				
Color temperature	5CCT switch (2,700/3,000/3,500/4,000/5,000 K), 5,000 K by default			
CRI	> 90			
Electrical system				
Input voltage	120-277 V			
Max input current	ASD-CDL7-4DA13AC	0.15 A	ASD-CDL7R-8A35WH	0.29 A
	ASD-CDL7-6DA22AC	0.23 A	ASD-CDL7-8DA40AC	0.43 A
	ASD-CDL7-6DA22AC-BK		ASD-CDL7-10DA40AC	0.5 A
	ASD-CDL7-6DA30AC	0.29 A	ASD-CDL7-10DA40AC-BK	
	ASD-CDL7R-6A30WH	0.25 A	ASD-CDL7R-10A40WH	0.33 A
	ASD-CDL7-8DA30AC	0.3 A	ASD-CDL7-10DA60AC	0.64 A
ASD-CDL7-8DA30AC-BK				
Inrush current (Action time)	ASD-CDL7-4DA13AC	30 A (0.3 S)	ASD-CDL7R-8A35WH	50 A (16 S)
	ASD-CDL7-6DA22AC	43 A (0.3 S)	ASD-CDL7-8DA40AC	44 A (0.3 S)
	ASD-CDL7-6DA22AC-BK		ASD-CDL7-10DA40AC	50 A (0.3 S)
	ASD-CDL7-6DA30AC	38 A (0.3 S)	ASD-CDL7-10DA40AC-BK	
	ASD-CDL7R-6A30WH	50 A (16 S)	ASD-CDL7R-10A40WH	50 A (16 S)
	ASD-CDL7-8DA30AC	37 A (0.3 S)	ASD-CDL7-10DA60AC	50 A (0.3 S)
ASD-CDL7-8DA30AC-BK				
Off state power	0W			
Power consumption	ASD-CDL7-4DA13AC	7/10/13W	ASD-CDL7R-8A35WH	16/22/26/30/35W
	ASD-CDL7-6DA22AC	10/15/22W	ASD-CDL7-8DA40AC	30/35/40W
	ASD-CDL7-6DA22AC-BK		ASD-CDL7-10DA40AC	20/30/40W
	ASD-CDL7-6DA30AC	20/25/30W	ASD-CDL7-10DA40AC-BK	
	ASD-CDL7R-6A30WH	12/16/22/26/30W	ASD-CDL7R-10A40WH	22/26/30/35/40W
	ASD-CDL7-8DA30AC	12/20/30W	ASD-CDL7-10DA60AC	40/50/60W
ASD-CDL7-8DA30AC-BK				
Power factor	> 0.9			
Output voltage	ASD-CDL7-4DA13AC	36 V	ASD-CDL7R-8A35WH	75 A
	ASD-CDL7-6DA22AC	30-42 V	ASD-CDL7-8DA40AC	30-42 V
	ASD-CDL7-6DA22AC-BK		ASD-CDL7-10DA40AC	36 V
	ASD-CDL7-6DA30AC		ASD-CDL7-10DA40AC-BK	
	ASD-CDL7R-6A30WH	75 A	ASD-CDL7R-10A40WH	75 A
	ASD-CDL7-8DA30AC	30-42 V	ASD-CDL7-10DA60AC	30-42 V
ASD-CDL7-8DA30AC-BK				
Max output current	ASD-CDL7-4DA13AC	0.33 A	ASD-CDL7R-8A35WH	0.45 A
	ASD-CDL7-6DA22AC	0.55 A	ASD-CDL7-8DA40AC	1 A
	ASD-CDL7-6DA22AC-BK		ASD-CDL7-10DA40AC	
	ASD-CDL7-6DA30AC	0.75 A	ASD-CDL7-10DA40AC-BK	
	ASD-CDL7R-6A30WH	0.37 A	ASD-CDL7R-10A40WH	0.52 A
	ASD-CDL7-8DA30AC	0.75 A	ASD-CDL7-10DA60AC	1.6 A
ASD-CDL7-8DA30AC-BK				
Surge protection DM/CM	2.5 kV / 2.5 kV		for CDL7R models: 2 kV / 2.5 kV	

For most up-to-date spec sheets please refer to [asd-lighting.com](http://asd-lighting.com)



# LED COMMERCIAL DOWNLIGHT

Dimming compatible controls				Regular and voluntary certifications	
Brand	Lutron		Leviton		5-year limited warranty
Models	DVSTV-WH	DVSTV-LA	DVTV-WH	DS 710-10Z	UL certified E473854 (except CDL7R models)
	DVSTV-BR	DVSTV-BL	DVSTV-IV	AWSMT-7DW	cETLus certified 5005153 (for CDL7R models)
	DVSTV-GR	DVSTV-AL			Energy Star listed (except CDL7R models)

## PACKAGE CONTENTS:

Description	Q-ty
LED Commercial Downlight Fixture	1
Wire nut (A)	3
Template for 4, 6, 8 or 10 inch (B)	1
Box	1

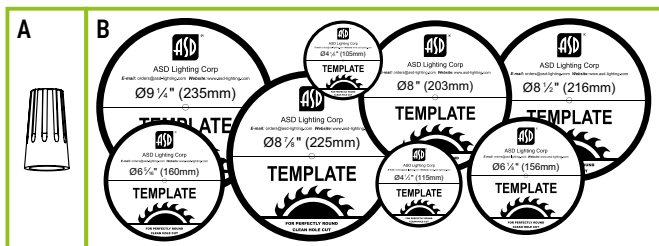

## BATTERY BACK-UP KIT INFORMATION

**BLD-HM08D** **BLD-HM15D** sold separately:

Specifications	model: BLD-HM08D	model: BLD-HM15D
Input voltage	120-347 Vac, 50/60 Hz	
Input current	≤ 100 mA	
Output voltage	≤ 170 Vdc	≤ 175 Vdc
Output power	8W	15W
Lumen	800 lm	1,000 lm
Application	< 60W (0-10 V dimmable fixture)	
Ambient temperature	32°F to 122°F (0°C to 50°C)	

## ACCESSORIES (sold separately):

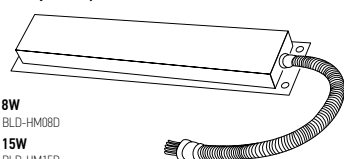
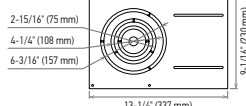
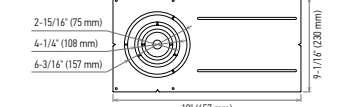
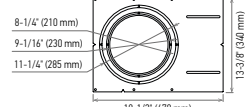
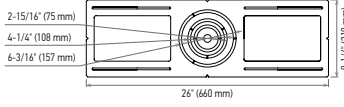
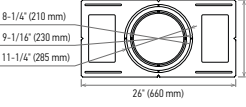
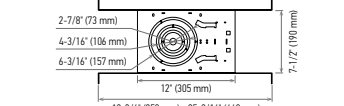
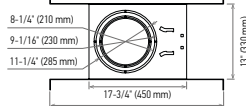
<b>Battery back-up kit</b>  <b>8W</b> BLD-HM08D <b>15W</b> BLD-HM15D	<b>New construction flat mounting plate with asymmetric round holes 3-4-6"</b> ASD-MPLR-346-FA-6PACK  2-15/16" (75 mm) 4-1/4" (108 mm) 6-3/16" (157 mm) 9-1/8" (230 mm) 13-1/4" (337 mm)
<b>New construction flat mounting plate 18" with asymmetric round holes 3-4-6"</b> ASD-MPLR18-346-FA-6PACK  2-15/16" (75 mm) 4-1/4" (108 mm) 6-3/16" (157 mm) 9-1/8" (230 mm) 18" (457 mm)	<b>New construction flat mounting plate with asymmetric round holes 8-10-12"</b> ASD-MPLR-81012-FA-6PACK  8-1/4" (210 mm) 9-1/16" (230 mm) 11-1/4" (285 mm) 13-3/8" (340 mm) 18-1/2" (470 mm)
<b>New construction flat mounting plate with symmetric round holes 3-4-6"</b> ASD-MPLR-346-FS-6PACK  2-15/16" (75 mm) 4-1/4" (108 mm) 6-3/16" (157 mm) 8-1/4" (210 mm) 26" (660 mm)	<b>New construction flat mounting plate with symmetric round holes 8-10-12"</b> ASD-MPLR-81012-FS-6PACK  8-1/4" (210 mm) 9-1/16" (230 mm) 11-1/4" (285 mm) 13" (330 mm) 26" (660 mm)
<b>New construction mounting plate with round holes and sliding clips 3-4-6"</b> ASD-MPLR-346-SC-6PACK  2-7/8" (73 mm) 4-3/16" (106 mm) 6-3/16" (157 mm) 7-1/2" (190 mm) 12" (305 mm) 13-3/4" (350 mm) - 25-3/16" (640 mm)	<b>New construction mounting plate with round holes and sliding clips 8-10-12"</b> ASD-MPLR-81012-SC-6PACK  8-1/4" (210 mm) 9-1/16" (230 mm) 11-1/4" (285 mm) 13" (330 mm) 17-3/4" (450 mm) - 25-3/16" (640 mm)

## ACCESSORY COMPATIBILITY LIST:

Accessories	Models	Accessories									
		Battery back-up kit 8W BLD-HM08D	Battery back-up kit 15W BLD-HM15D	New construction flat mounting plate with asymmetric round holes 3-4-6" ASD-MPLR-346-FA-6PACK	New construction flat mounting plate 18" with asymmetric round holes 3-4-6" ASD-MPLR18-346-FA-6PACK	New construction flat mounting plate with asymmetric round holes 8-10-12" ASD-MPLR-81012-FA-6PACK	New construction flat mounting plate with symmetric round holes 3-4-6" ASD-MPLR-346-FS-6PACK	New construction flat mounting plate with symmetric round holes 8-10-12" ASD-MPLR-81012-FS-6PACK	New construction mounting plate with round holes and sliding clips 3-4-6" ASD-MPLR-346-SC-6PACK	New construction mounting plate with round holes and sliding clips 8-10-12" ASD-MPLR-81012-SC-6PACK	
ASD-CDL7/ ASD-CDL7R	4 inch	•	•	•	•	•	•	•	•	•	•
	6 inch	•	•	•	•	•	•	•	•	•	•
	8 inch	•	•	•	•	•	•	•	•	•	•
	10 inch	•	•	•	•	•	•	•	•	•	•

For most up-to-date spec sheets please refer to [asd-lighting.com](http://asd-lighting.com)



# LED COMMERCIAL DOWNLIGHT

## INSTALLATION GUIDE

### IMPORTANT SAFETY INFORMATION:

Please read all the instructions below before installation.

- ▶ Make sure that the supply voltage corresponds to the rated product voltage.
- ▶ The product must be installed by a qualified electrician in accordance with the National Electrical Code and corresponding local codes.
- ▶ If the product is damaged, do not use it.

### ⚠ WARNING

**RISK OF PERSONAL INJURY – READ and follow all WARNINGS and installation instructions.** Keep or give to the owner for future reference.

**Risk of cuts:** Wear gloves to prevent cuts or abrasions when removing from carton, handling, installing, and maintaining this product.

**Risk of electric shock:** This product must be installed in accordance with the applicable installation code by a person familiar with the construction and operation of the product and the hazards involved.

**Risk of Fire:** Minimum 194°F supply conductors. Consult a qualified electrician to ensure correct branch circuit conductor.

ASD® assumes no responsibility for claims arising out of improper or careless installation or handling of this product.

### INSTALLATION STEPS:

1. Use template to cut an appropriate sized hole. Secure the safety latch onto a structural part of the original fixture housing above the ceiling. Connect the wires using wire nuts: Black to Black, White to White, Green to Green.
2. Before inserting the fixture into the mounting surface opening, choose power and color temperature with a simple switch. Fold up the two spring mounting tabs and release as the fixture is placed into the mounting surface.
3. Ensure that the spring mounting tabs have securely mounted the fixture so that the front trim is flush against the mounting surface.

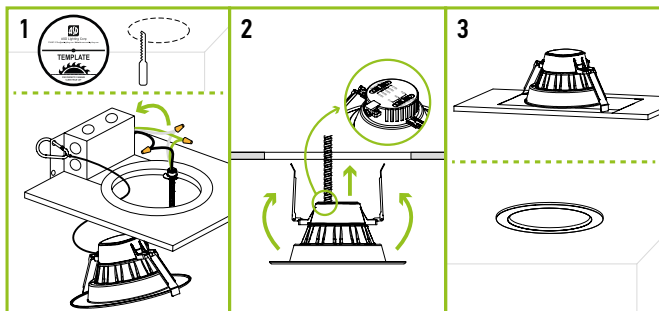

### ELECTRICAL SCHEMATIC DIAGRAM:

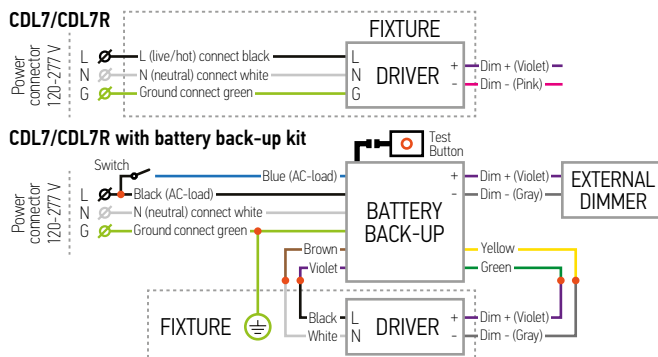

### BATTERY BACK-UP KIT INSTALLATION:

1. Secure the battery back-up to the ceiling (brackets not included).
2. Connect wires as shown on electrical diagram.
3. Connect test switch and affix it in the hole on surface.

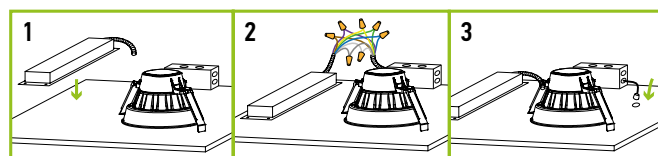

### MOUNTING PLATE INSTALLATION

ASD-MPLR-346-FA	ASD-MPLR18-346-FA	ASD-MPLR-81012-FA
ASD-MPLR-346-FS	ASD-MPLR-81012-FS	ASD-MPLR-346-SC
ASD-MPLR-81012-SC	sold separately:	

1. Remove the metal ring from the mounting plate according to the size of fixture.
2. Place the mounting plate and secure its position with screws on the beams.

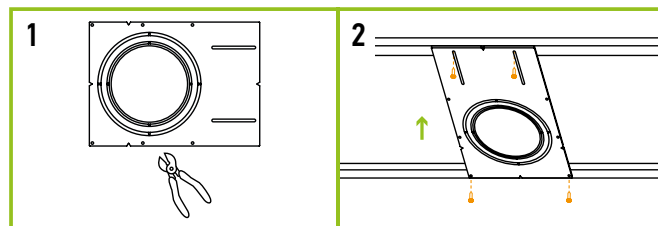

For most up-to-date spec sheets please refer to [asd-lighting.com](http://asd-lighting.com)



# LED COMMERCIAL DOWNLIGHT

## ORDERING INFORMATION

Model	UPC	Pcs. per carton	Carton size	Carton weight	GTIN 14
<b>DOWNLIGHTS CDL7</b>					
ASD-CDL7-4DA13AC	810050736121	8	16.1" x 14.4" x 7.1"	9.3 lbs	30810050736122
ASD-CDL7-6DA22AC	810050736022	8	19.1" x 18.1" x 10"	15.7 lbs	30810050736023
ASD-CDL7-6DA22AC-BK	810050739443	8	19.1" x 18.1" x 10"	15.7 lbs	10810050739440
ASD-CDL7-6DA30AC	810050739825	8	19.1" x 18.1" x 10"	15.7 lbs	10810050739822
ASD-CDL7-8DA30AC	810050736039	4	18.9" x 11.4" x 11.6"	9.1 lbs	10810050736036
ASD-CDL7-8DA30AC-BK	810050739450	4	18.9" x 11.4" x 11.6"	9.1 lbs	10810050739457
ASD-CDL7-8DA40AC	819201025459	4	18.9" x 11.4" x 11.6"	9.1 lbs	10819201025456
ASD-CDL7-10DA40AC	810050736046	4	23.6" x 12.6" x 13"	12.1 lbs	10810050736043
ASD-CDL7-10DA40AC-BK	810050739832	4	23.6" x 12.6" x 13"	12.1 lbs	10810050739839
ASD-CDL7-10DA60AC	819201023721	4	23.6" x 12.6" x 13"	12.1 lbs	10819201023728
<b>DOWNLIGHT CDL7R 120lm/W</b>					
ASD-CDL7R-6A30WH	810128113359	8	18.9" x 18.5" x 12.2"	14.4 lbs	10810128113356
ASD-CDL7R-8A35WH	810128113366	4	22.8" x 11.8" x 13"	9.9 lbs	10810128113363
ASD-CDL7R-10A40WH	810128113373	4	25.6" x 13.2" x 14.2"	12.3 lbs	10810128113370

## ACCESSORIES:

Model	Description	UPC	Pcs. per carton	Carton size	Carton weight	GTIN 14
BLD-HM08D	Battery back-up kit 8W	810128111508	10	14.4" x 13.8" x 9.3"	19.6 lbs	10810128111505
BLD-HM15D	Battery back-up kit 15W	810050734882	10	18.5" x 13.4" x 11.8"	25.6 lbs	10810050734889
ASD-MPLR-346-FA-6PACK	New construction flat mounting plate with asymmetric round holes 3-4-6"	810050739344	4	14.4" x 9.8" x 3.2"	22.5 lbs	10810050739341
ASD-MPLR18-346-FA-6PACK	New construction flat mounting plate 18" with asymmetric round holes 3-4-6"	810128112826	4	18.9" x 9.8" x 3.2"	32.9 lbs	10810128112823
ASD-MPLR-81012-FA-6PACK	New construction flat mounting plate with asymmetric round holes 8-10-12"	810128111553	4	19.5" x 14.2" x 3.2"	38.7 lbs	10810128111550
ASD-MPLR-346-FS-6PACK	New construction flat mounting plate with symmetric round holes 3-4-6"	810050739351	4	27.2" x 9.1" x 3.2"	25.2 lbs	10810050739358
ASD-MPLR-81012-FS-6PACK	New construction flat mounting plate with symmetric round holes 8-10-12"	810128111577	4	27" x 13.8" x 3.2"	42.9 lbs	10810128111574
ASD-MPLR-346-SC-6PACK	New construction mounting plate with round holes and sliding clips 3-4-6"	810050739337	2	17.3" x 11.9" x 13.4"	17 lbs	10810050739334
ASD-MPLR-81012-SC-6PACK	New construction mounting plate with round holes and sliding clips 8-10-12"	810128111607	2	21.3" x 17.5" x 15.6"	24.7 lbs	10810128111604

For most up-to-date spec sheets please refer to [asd-lighting.com](http://asd-lighting.com)

ASD LIGHTING CORP

E-mail: [orders@asd-lighting.com](mailto:orders@asd-lighting.com) | Web site: [www.asd-lighting.com](http://www.asd-lighting.com)

