



LED UFO HIGH BAY WITH Q-BASE

► **DESIGN** - LED UFO HIGH BAY Q-BASE has a built-in motion sensor base, allowing you to install the microwave motion or PIR sensor. Die-cast aluminum housing with excellent heat dissipation along with an anti-glare PC lens provide many years of use. It can operate in temperatures ranging from -40 to 140°F. It runs on 120-277V or 277-480V circuits with a 0-10V dimmable driver.

► **COLOR AND POWER SELECTABLE** - You can choose either a 3,000K warm white, 4,000K cool white or 5,000K daylight color temperature, and change the power with a simple switch.

► **IP69K** - rating provides protection against ingress of dust and high temperature, high pressure water.

► **SURGE PROTECTION** - 6kV protects the fixture from voltage spikes and current surges.

► **INSTALLATION** - This fixture has three different mounting options: suspended, surface, and pendant. It comes with 4 ft cord. Perfect commercial or industrial solution for warehouses, supermarkets, retail stores, gyms, and many other applications.

► **ADVANTAGES** - With calculated lifespan up to 155,000 hours, these fixtures are made to last decades under normal operation! ASD provides a 5-year limited warranty along with UL and DLC Premium certifications to guarantee top quality products and safety!

Catalog number	
Notes	
Type	



Model	Watts	Voltage	Dimmable	Lumens	CCT	Finish	Dimensions (LxWxH)	Cord
UHB3								
ASD-UHB3-100DAC-BK	100W	120-277 V	0-10 V	up to 15,017 lm	3CCT (3,000/4,000/5,000 K)	Black	10-1/4" x 10-1/4" x 6-7/16"	4 ft
ASD-UHB3-100ADAC-BK	60/80/100W	120-277 V	0-10 V	up to 14,603 lm	3CCT (3,000/4,000/5,000 K)	Black	10-1/4" x 10-1/4" x 6-7/16"	4 ft
ASD-UHB3-150DAC-BK	150W	120-277 V	0-10 V	up to 22,570 lm	3CCT (3,000/4,000/5,000 K)	Black	10-1/4" x 10-1/4" x 6-7/16"	4 ft
ASD-UHB3-150ADAC-WH	100/120/150W	120-277 V	0-10 V	up to 21,521 lm	3CCT (3,000/4,000/5,000 K)	White	10-1/4" x 10-1/4" x 6-7/16"	4 ft
ASD-UHB3-150ADAC-BK	100/120/150W	120-277 V	0-10 V	up to 21,521 lm	3CCT (3,000/4,000/5,000 K)	Black	10-1/4" x 10-1/4" x 6-7/16"	4 ft
ASD-UHB3-200ADAC-WH	100/150/200W	120-277 V	0-10 V	up to 30,407 lm	3CCT (3,000/4,000/5,000 K)	White	12-5/8" x 12-5/8" x 6-15/16"	4 ft
ASD-UHB3-200ADAC-BK	100/150/200W	120-277 V	0-10 V	up to 30,407 lm	3CCT (3,000/4,000/5,000 K)	Black	12-5/8" x 12-5/8" x 6-15/16"	4 ft
ASD-UHB3-240DAC-BK	240W	120-277 V	0-10 V	up to 37,169 lm	3CCT (3,000/4,000/5,000 K)	Black	12-5/8" x 12-5/8" x 6-5/8"	4 ft
ASD-UHB3-240ADAC-BK	150/200/240W	120-277 V	0-10 V	up to 34,912 lm	3CCT (3,000/4,000/5,000 K)	Black	12-5/8" x 12-5/8" x 6-15/16"	4 ft
ASD-UHB3-300DAC-BK	300W	120-277 V	0-10 V	up to 44,960 lm	3CCT (3,000/4,000/5,000 K)	Black	12-5/8" x 12-5/8" x 7-11/16"	4 ft
ASD-UHB3-300ADAC-BK	200/240/300W	120-277 V	0-10 V	up to 40,913 lm	3CCT (3,000/4,000/5,000 K)	Black	12-5/8" x 12-5/8" x 7-11/16"	4 ft
ASD-UHB3-400D50-BK	400W	120-277 V	0-10 V	58,725 lm	5,000 K	Black	16-9/16" x 16-9/16" x 9-1/8"	4 ft
ASD-UHB3-500D50-BK	500W	120-277 V	0-10 V	72,413 lm	5,000 K	Black	16-9/16" x 16-9/16" x 9-1/8"	4 ft
ASD-UHB3-500ADAC-BK	300/400/500W	120-277 V	0-10 V	up to 69,777 lm	3CCT (3,000/4,000/5,000 K)	Black	16-9/16" x 16-9/16" x 9-1/8"	4 ft
UHB3HV HIGH VOLTAGE								
ASD-UHB3HV-150D50-BK	150W	277-480 V	0-10 V	22,200 lm	5,000 K	Black	10-1/4" x 10-1/4" x 6-7/16"	4 ft
ASD-UHB3HV-200D50-BK	200W	277-480 V	0-10 V	29,600 lm	5,000 K	Black	12-5/8" x 12-5/8" x 6-13/16"	4 ft
ASD-UHB3HV-300ADAC-BK	200/240/300W	277-480 V	0-10 V	up to 39,042 lm	3CCT (3,000/4,000/5,000 K)	Black	12-5/8" x 12-5/8" x 7-11/16"	4 ft
ASD-UHB3HV-400D50-BK	400W	277-480 V	0-10 V	58,651 lm	5,000 K	Black	16-9/16" x 16-9/16" x 10-3/8"	4 ft
ASD-UHB3HV-500D50-BK	500W	277-480 V	0-10 V	70,425 lm	5,000 K	Black	16-9/16" x 16-9/16" x 10-3/8"	4 ft
ASD-UHB3HV-500ADAC-BK	300/400/500W	277-480 V	0-10 V	up to 70,715 lm	3CCT (3,000/4,000/5,000 K)	Black	16-9/16" x 16-9/16" x 10-3/8"	4 ft
SENSORS AND REMOTE								
ASD-09MW-WH	Microwave motion sensor 3pin white						2-1/8" x 2-1/8" x 1-5/16"	-
ASD-09MW-BK	Microwave motion sensor 3pin black						2-1/8" x 2-1/8" x 1-5/16"	-
ASD-09IR-WH	Infrared motion sensor 3pin white						2-1/8" x 2-1/8" x 1-11/16"	-
ASD-09IR-BK	Infrared motion sensor 3pin black						2-1/8" x 2-1/8" x 1-11/16"	-
ASD-06RC	Remote control for motion sensor						5-11/16" x 1-3/4" x 13/16"	-
ASD-09MW-NLS-WH	Microwave motion sensor smart 3pin white						2-1/8" x 2-1/8" x 1-3/8"	-
ASD-09IR-NLS-WH	Infrared motion sensor smart 3pin white						2-1/8" x 2-1/8" x 1-11/16"	-
ASD-06RC-NLS	Remote control for motion sensor smart						5-11/16" x 1-3/4" x 13/16"	-

For detailed luminous flux information please refer to Annex 1, page 10.

For most up-to-date spec sheets please refer to asd-lighting.com

ASD LIGHTING CORP

E-mail: orders@asd-lighting.com | Web site: www.asd-lighting.com





LED UFO HIGH BAY WITH Q-BASE

PRODUCT SPECIFICATIONS:

Construction & Materials						
Housing	Die-cast aluminum					
Lens	PC					
Finish	White, Black					
Weight	ASD-UHB3-100DAC-BK	4.8 lbs (2.2 kg)	ASD-UHB3-240DAC-BK	7.1 lbs (3.2 kg)	ASD-UHB3HV-150D50-BK	5.2 lbs (2.4 kg)
	ASD-UHB3-100ADAC-BK	4.9 lbs (2.2 kg)	ASD-UHB3-240ADAC-BK		ASD-UHB3HV-200D50-BK	8.9 lbs (4 kg)
	ASD-UHB3-150DAC-BK	4.8 lbs (2.2 kg)	ASD-UHB3-300DAC-BK	10.5 lbs (4.8 kg)	ASD-UHB3HV-300ADAC-BK	10.6 lbs (4.8 kg)
	ASD-UHB3-150ADAC-WH	4.9 lbs (2.2 kg)	ASD-UHB3-300ADAC-BK	9.9 lbs (4.5 kg)	ASD-UHB3HV-400D50-BK	22.4 lbs (10.2 kg)
	ASD-UHB3-150ADAC-BK		ASD-UHB3-400D50-BK			
	ASD-UHB3-200ADAC-WH	7.1 lbs (3.2 kg)	ASD-UHB3-500D50-BK	17.4 lbs (7.9 kg)	ASD-UHB3HV-500D50-BK	22.5 lbs (10.2 kg)
	ASD-UHB3-200ADAC-BK		ASD-UHB3-500ADAC-BK			
Environmental system						
Work environment	Suitable for Wet Locations, IP65/69K					
Operating temperature	-40°F to 140°F (-40°C to 60°C) *					
L-70 Life	ASD-UHB3-100DAC-BK	R > 54,000 hrs; C > 155,000 hrs	ASD-UHB3-240DAC-BK	R > 54,000 hrs; C > 155,000 hrs	ASD-UHB3HV-150D50-BK	R > 54,000 hrs; C > 146,000 hrs
	ASD-UHB3-100ADAC-BK	R > 54,000 hrs; C > 141,000 hrs	ASD-UHB3-240ADAC-BK	R > 54,000 hrs; C > 141,000 hrs	ASD-UHB3HV-200D50-BK	
	ASD-UHB3-150DAC-BK	R > 54,000 hrs; C > 155,000 hrs	ASD-UHB3-300DAC-BK	R > 54,000 hrs; C > 155,000 hrs	ASD-UHB3HV-300ADAC-BK	R > 50,000 hrs; C > 166,000 hrs
	ASD-UHB3-150ADAC-WH	R > 54,000 hrs; C > 141,000 hrs	ASD-UHB3-300ADAC-BK	R > 50,000 hrs; C > 166,000 hrs	ASD-UHB3HV-400D50-BK	R > 47,000 hrs; C > 157,000 hrs
	ASD-UHB3-150ADAC-BK		ASD-UHB3-400D50-BK	R > 47,000 hrs; C > 157,000 hrs	ASD-UHB3HV-500D50-BK	
	ASD-UHB3-200ADAC-WH		ASD-UHB3-500D50-BK	R > 48,000 hrs; C > 158,000 hrs	ASD-UHB3HV-500ADAC-BK	R > 48,000 hrs; C > 141,000 hrs
	ASD-UHB3-200ADAC-BK		ASD-UHB3-500ADAC-BK	R > 48,000 hrs; C > 158,000 hrs		
Optical system						
Color temperature	5,000 K					
	3CCT switch (3,000/4,000/5,000 K), 5,000 K by default					
CRI	> 80					
Electrical system						
Input voltage	Regular voltage: 120-277 V High voltage: 277-480 V					
Max input current	ASD-UHB3-100DAC-BK	1.6 A	ASD-UHB3-240DAC-BK	3 A	ASD-UHB3HV-150D50-BK	2 A
	ASD-UHB3-100ADAC-BK		ASD-UHB3-240ADAC-BK		ASD-UHB3HV-200D50-BK	2.6 A
	ASD-UHB3-150DAC-BK	2 A	ASD-UHB3-300DAC-BK	4 A	ASD-UHB3HV-300ADAC-BK	2.1 A
	ASD-UHB3-150ADAC-WH		ASD-UHB3-300ADAC-BK		ASD-UHB3HV-400D50-BK	5 A
	ASD-UHB3-150ADAC-BK	2.6 A	ASD-UHB3-400D50-BK	5 A	ASD-UHB3HV-500D50-BK	7 A
	ASD-UHB3-200ADAC-WH		ASD-UHB3-500D50-BK		7 A	
	ASD-UHB3-200ADAC-BK		ASD-UHB3-500ADAC-BK		5.8 A	
Inrush current (Action time)	80 A (0.5 S)					
Off state power	0W					
Power consumption	ASD-UHB3-100DAC-BK	100W	ASD-UHB3-240DAC-BK	240W	ASD-UHB3HV-150D50-BK	150W
	ASD-UHB3-100ADAC-BK	60/80/100W	ASD-UHB3-240ADAC-BK	150/200/240W	ASD-UHB3HV-200D50-BK	200W
	ASD-UHB3-150DAC-BK	150W	ASD-UHB3-300DAC-BK	300W	ASD-UHB3HV-300ADAC-BK	200/240/300W
	ASD-UHB3-150ADAC-WH	100/120/150W	ASD-UHB3-300ADAC-BK	200/240/300W	ASD-UHB3HV-400D50-BK	400W
	ASD-UHB3-150ADAC-BK		ASD-UHB3-400D50-BK	400W	ASD-UHB3HV-500D50-BK	500W
	ASD-UHB3-200ADAC-WH	100/150/200W	ASD-UHB3-500D50-BK	500W	ASD-UHB3HV-500ADAC-BK	300/400/500W
	ASD-UHB3-200ADAC-BK		ASD-UHB3-500ADAC-BK	300/400/500W		
Power factor	> 0.9					
Output voltage	ASD-UHB3-100DAC-BK	180-260 V	ASD-UHB3-240DAC-BK	180-260 V	ASD-UHB3HV-150D50-BK	260 V
	ASD-UHB3-100ADAC-BK		ASD-UHB3-240ADAC-BK		ASD-UHB3HV-200D50-BK	
	ASD-UHB3-150DAC-BK		ASD-UHB3-300DAC-BK	215 V	ASD-UHB3HV-300ADAC-BK	114-228 V
	ASD-UHB3-150ADAC-WH		ASD-UHB3-300ADAC-BK	114-228 V	ASD-UHB3HV-400D50-BK	215 V
	ASD-UHB3-150ADAC-BK		ASD-UHB3-400D50-BK	215 V	ASD-UHB3HV-500D50-BK	
	ASD-UHB3-200ADAC-WH		ASD-UHB3-500D50-BK	215 V	ASD-UHB3HV-500ADAC-BK	
	ASD-UHB3-200ADAC-BK		ASD-UHB3-500ADAC-BK	114-228 V		
Max output current	ASD-UHB3-100DAC-BK	0.4 A	ASD-UHB3-240DAC-BK	0.97 A	ASD-UHB3HV-150D50-BK	0.3 A
	ASD-UHB3-100ADAC-BK		ASD-UHB3-240ADAC-BK		ASD-UHB3HV-200D50-BK	0.8 A
	ASD-UHB3-150DAC-BK	0.6 A	ASD-UHB3-300DAC-BK	1.25 A	ASD-UHB3HV-300ADAC-BK	1.4 A
	ASD-UHB3-150ADAC-WH		ASD-UHB3-300ADAC-BK	1.75 A	ASD-UHB3HV-400D50-BK	1.66 A
	ASD-UHB3-150ADAC-BK	0.8 A	ASD-UHB3-400D50-BK	1.66 A	ASD-UHB3HV-500D50-BK	2.075 A
	ASD-UHB3-200ADAC-WH		ASD-UHB3-500D50-BK	2.075 A		
	ASD-UHB3-200ADAC-BK		ASD-UHB3-500ADAC-BK	2.075 A		
Surge protection DM/CM	4 kV / 6 kV for ASD-UHB3-300DAC-BK, ASD-UHB3-300ADAC-BK, ASD-UHB3-400D50-BK, ASD-UHB3-500D50-BK, ASD-UHB3-500ADAC-BK, ASD-UHB3HV-300ADAC-BK, ASD-UHB3HV-400D50-BK, ASD-UHB3HV-500D50-BK, ASD-UHB3HV-500ADAC-BK models: 6 kV / 6 kV					
Dimming compatible controls						
Brand	Lutron		Leviton			
Models	DVSTV	DVTV	DS710			
Regular and voluntary certifications						
5-year limited warranty						
DesignLights Consortium (DLC) listed (classification: Premium) Main: Indoor luminaires; General application: High-bay, Primary use: High-bay luminaires for commercial and industrial buildings.						
UL listed E473804						

* Under extreme conditions fixture may enter protection mode. If ambient temperature exceeds 140°F (60°C) for an extended period of time, lumen output will decrease to 60% capacity. At higher sustained temperatures protection mode will terminate power to the fixture.

PACKAGE CONTENTS:

Description	Q-ty
LED UFO High Bay with Q-Base	1
Mounting ring (A)	1
Box	1





For most up-to-date spec sheets please refer to asd-lighting.com

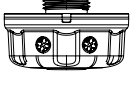
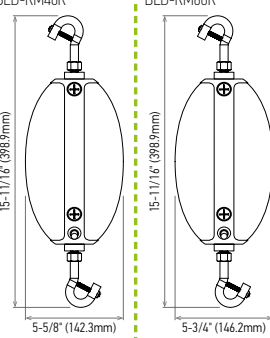
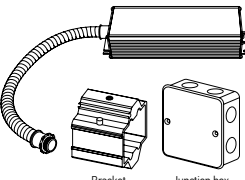
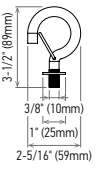
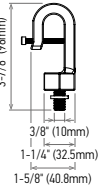
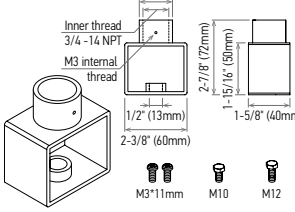
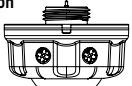
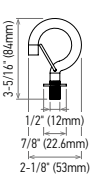
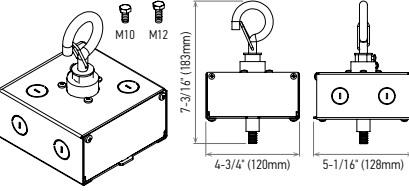

LED UFO HIGH BAY WITH Q-BASE

ACCESSORIES (sold separately):

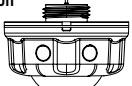
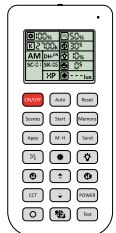
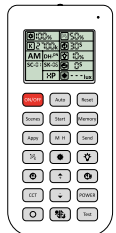
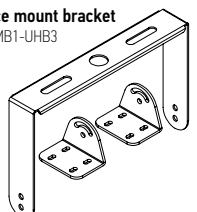
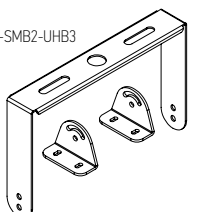
Microwave motion sensor 3pin ASD-09MW 	Battery back-up kit 40W BLD-RM40R 60W BLD-RM60R  15-11/16" (398.9mm) 5-5/8" (142.3mm) 15-11/16" (398.9mm) 5-3/4" (146.2mm)	Battery back-up kit 60W for 277-480V BLD-GM60R-HV  Bracket Junction box M5*7mm M5*16mm Ring G-hook Wiring cap Remote test switch for battery back-up kit RN1	Spring hook ASD-H-M10  3-1/2" (89mm) 3/8" (10mm) 1" (25mm) 2-5/16" (59mm)	Screw-bolt hook ASD-HS-M10  3-7/8" (98mm) 3/8" (10mm) 1-1/4" (32.5mm) 1-5/8" (40.8mm)	Pendant mount bracket ASD-PMB-UHB 1-1/4" (32mm)  Inner thread 3/4"-14 NPT M3 internal thread 1/2" (13mm) 2-7/8" (72mm) 1-5/16" (30mm) 1-5/8" (40mm) M3*11mm M10 M12
Infrared motion sensor 3pin ASD-09IR 			Spring hook ASD-H-M12  3-5/16" (86mm) 1/2" (12mm) 7/8" (22.6mm) 2-1/8" (53mm)	Pendant mount bracket with j-box and spring hook ASD-PMB-JB-UHB  M10 M12 7-3/16" (183mm) 4-3/4" (120mm) 5-1/16" (128mm)	
Microwave motion sensor smart 3pin ASD-09MW-NLS 					
Infrared motion sensor smart 3pin ASD-09IR-NLS 					
Remote control for motion sensor ASD-06RC 					
Remote control for motion sensor smart ASD-06RC-NLS 					
	Surface mount bracket ASD-SMB1-UHB3  M5*14mm M5*14mm nut M6*16mm nut 6-11/16" (170mm) 2-5/8" (67mm) 10-1/16" (256mm)				Surface mount bracket ASD-SMB2-UHB3  M5*14mm M5*14mm M6*16mm nut 8-1/4" (210.2mm) 2-5/8" (67mm) 12-5/16" (313.6mm)

ACCESSORY COMPATIBILITY LIST:

Models	Accessories													
	Microwave motion sensor 3pin ASD-09MW-WH ASD-09MW-BK	Infrared motion sensor 3pin ASD-09IR-WH ASD-09IR-BK	Microwave motion sensor smart 3pin ASD-09MW-NLS-WH	Infrared motion sensor smart 3pin ASD-09IR-NLS-WH	Battery back-up kit 40W BLD-RM40R	Battery back-up kit 60W BLD-RM60R	Battery back-up kit 60W for 277-480V BLD-GM60R-HV	Spring hook M10 ASD-H-M10	Spring hook M12 ASD-H-M12	Screw-bolt hook M10 ASD-HS-M10	Pendant mount bracket ASD-PMB-UHB	Pendant mount bracket with j-box and spring hook ASD-PMB-JB-UHB	Surface mount bracket ASD-SMB1-UHB3-WH ASD-SMB1-UHB3-BK	Surface mount bracket ASD-SMB2-UHB3-BK
ASD-UHB3-100DAC-BK	•	•	•	•	•	•	•	•	•	•	•	•	•	•
ASD-UHB3-100ADAC-BK	•	•	•	•	•	•	•	•	•	•	•	•	•	•
ASD-UHB3-150DAC-BK	•	•	•	•	•	•	•	•	•	•	•	•	•	•
ASD-UHB3-150ADAC-WH	•	•	•	•	•	•	•	•	•	•	•	•	•	•
ASD-UHB3-150ADAC-BK	•	•	•	•	•	•	•	•	•	•	•	•	•	•
ASD-UHB3-200ADAC-WH	•	•	•	•	•	•	•	•	•	•	•	•	•	•
ASD-UHB3-200ADAC-BK	•	•	•	•	•	•	•	•	•	•	•	•	•	•
ASD-UHB3-240DAC-BK	•	•	•	•	•	•	•	•	•	•	•	•	•	•
ASD-UHB3-240ADAC-BK	•	•	•	•	•	•	•	•	•	•	•	•	•	•
ASD-UHB3-300DAC-BK	•	•	•	•	•	•	•	•	•	•	•	•	•	•
ASD-UHB3-300ADAC-BK	•	•	•	•	•	•	•	•	•	•	•	•	•	•
ASD-UHB3-400D50-BK	•	•	•	•	•	•	•	•	•	•	•	•	•	•
ASD-UHB3-500D50-BK	•	•	•	•	•	•	•	•	•	•	•	•	•	•
ASD-UHB3-500ADAC-BK	•	•	•	•	•	•	•	•	•	•	•	•	•	•
ASD-UHB3HV-150D50-BK	•	•	•	•	•	•	•	•	•	•	•	•	•	•
ASD-UHB3HV-200D50-BK	•	•	•	•	•	•	•	•	•	•	•	•	•	•
ASD-UHB3HV-300ADAC-BK	•	•	•	•	•	•	•	•	•	•	•	•	•	•
ASD-UHB3HV-400D50-BK	•	•	•	•	•	•	•	•	•	•	•	•	•	•
ASD-UHB3HV-500D50-BK	•	•	•	•	•	•	•	•	•	•	•	•	•	•
ASD-UHB3HV-500ADAC-BK	•	•	•	•	•	•	•	•	•	•	•	•	•	•

Note: Battery back-up kit and the Motion sensor kit can not work together. Please install one at a time.

For most up-to-date spec sheets please refer to asd-lighting.com



LED UFO HIGH BAY WITH Q-BASE

MOTION SENSOR INFORMATION

REMOTE CONTROL **ASD-06RC** **ASD-06RC-NLS** sold separately:

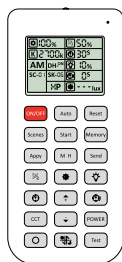

Button	Remarks	Button	Remarks	Button	Remarks
ON/OFF	ON/OFF Turn the sensor ON/OFF.	M H	Mounting height Adjust detection area/sensitivity levels according to real installation situations, higher or lower.	↑	Up The main functional buttons to adjust the factors to desired level.
Auto	Auto Enter "sensor mode" and perform previous settings.	Send	Send Memorize and send out the previous setting of individual parameters.	↓	Down Press + - button to dim light directly in non-detection mode.
Reset	Reset Enter "sensor mode" and perform the default settings.	☞	Detection range Also known as "sensitivity", 100 % means the highest sensitivity and longest distance. Use this button and the + - buttons to adjust.	CCT	CCT Selectable Not applicable to this product.
Scenes	Scenes Shows current settings saved in remote.	☞	Daylight sensor The preset lux level at which motion will be detected. Use this button and the + - buttons to adjust.	POWER	Power Adjust brightness in both ON/OFF mode & sensor mode, minimum 10%, max 100%, each time this button is pressed it changes by 5%.
Start	Start Press this to begin scene setup.	☞	Stand-by dimming After hold time, the light will dim from 100 % to optional standby dimming levels. Use this button and the + - buttons to adjust.	○	Reserved Button Not applicable to this product.
Memory	Memory Saves the scene settings.	☞	Hold time The period that light will stay illuminated 100 % after no motion is detected. Use this button and the + - buttons to adjust.	☞	Daylight Harvesting Daylight harvesting function enabled or disabled.
Apply	Apply Applies current scene settings to the fixture.	☞	Stand-by period The period after holdtime, during which the light keeps standby dimming level. Use this button and the + - buttons to adjust.	Test	Test button Press this button to test the sensor; it will temporarily change the hold time to 2s. This setting cannot be saved.

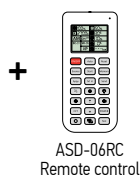
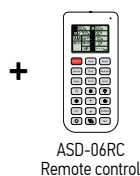

ASD-09MW, ASD-09MW-NLS:

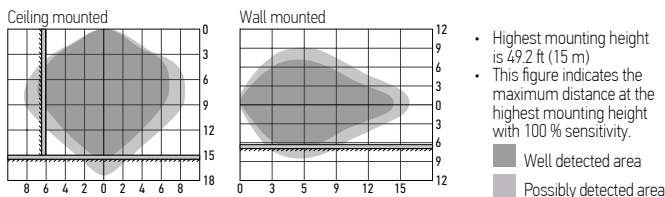

User notes:

1. Microwaves can penetrate walls or glass thinner than 0.8" but will be impaired if thicker than 0.8".
2. The driver voltage shall be stable and float within 10 %.
3. Detection area will be affected by speed of motion, mounting height and movement volume.
4. Conduct testing with adequate ambient lighting for best results.
5. Dimming performance differs when connected to different drivers; If the driver can't completely turn OFF, sensor can't either.
6. The first time powered ON sensor, light will be ON 100% for about 10S then dims to standby level or OFF.

Installation precautions:

1. Suitable for ceiling mount installation, adjust sensitivity properly if it's installed on side-wall because it gets more sensitive.
2. Make sure the microwave module is completely exposed.
3. The detection surface of the sensor module should be installed facing the detection area.

Application environment:

1. Suitable for indoor application, half/completely outdoor environment conditions might trigger the sensor.
2. Shall be mounted securely, to avoid any false triggers caused by movement of the fixture itself.
3. Keep the sensor module away from AC input and DC output to avoid high/low frequency signal interference.

Specifications	Models: ASD-09MW, ASD-09MW-NLS	Models: ASD-09IR, ASD-09IR-NLS
Operating voltage	10-15 V	
Operating current	< 30 mA	< 15 mA
Detection area	25 %/50 %/75 %/100 %	
Hold time	Remote control: 5 s/30 s/1 min/3 min/5 min/10 min/20 min/30 min Built-in switch: 5 s/1 min/5 min/10 min	
Daylight threshold	2 lux (0.2 fc)/10 lux (0.9 fc)/30 lux (2.8 fc)/50 lux (4.7 fc)/80 lux (7.4 fc)/120 lux (11.2 fc)/200 lux (18.6 fc)/250 lux (23.2 fc)/300 lux (27.9 fc)/350 lux (32.5 fc)/400 lux (37.2 fc)/disable	
Standby period	0 s/10 s/30 s/1 min/5 min/10 min/30 min/60 min/+ ∞	
Standby dimming level	Remote control: 10 %/20 %/30 %/50 % Built-in switch: 0 %/10 %/30 %/50 %	
Mounting height	max 49.2 ft (15 m)	≤ 39.4 ft (12 m)
Detection range	≥ 9 ft (3 m)	
Operating frequency	5.8 GHz ± 75 GHz	-
Transmitting power	< 0.3 mW	-

ASD-09IR, ASD-09IR-NLS:

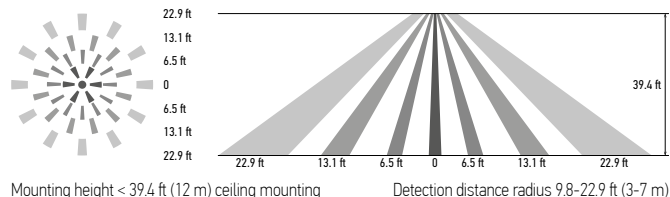

User notes:

1. The driver voltage shall be stable and float within 10%.
2. Detection area options may NOT working obviously because it works depends on fresnel lens, it's physically defined.
3. Detection distance performance works better when moving parallel to the sensor as opposed to towards it.
4. Conduct testing with adequate ambient lighting for best results.
5. Dimming performance differs when connected to different drivers; If the driver can't completely turn OFF, sensor can't either.
6. The first time powering ON the sensor, light will be ON 100% for about 45S then dims to standby level or OFF.

Installation precautions:

1. PIR sensor can't be placed inside any material, fresnel lens must be completely exposed in air.
2. Fresnel lens of the PIR sensor must be lower than light fixture.
3. Suitable for ceiling mount installation, adjust sensitivity properly if it's installed on a wall because it will become more sensitive.

Application environment:

1. Suitable for indoor application, half/completely outdoor environment conditions might trigger the sensor.
2. Not suitable environment if there's sudden changed temperature of airflow for PIR sensor.
3. Not suitable environment if there's shelves between the sensor and target area.
4. Shall be mounted securely, to avoid any false triggers caused by movement of the fixture itself.

DEFAULT SETTING:

Specifications	
Detection area	100 %
Hold time	10 min
Daylight threshold	Disable
Stand-by period	0 s
Stand-by dimming level	10 %

For most up-to-date spec sheets please refer to asd-lighting.com



LED UFO HIGH BAY WITH Q-BASE

WITH DUSK/DAWN FUNCTION:

1. With insufficient ambient brightness, sensor turns on light and keeps it at standby dimming level even if there is no motion or presence.
2. When sensor detects motion or presence it will bring the light level up to 100 %.
3. After motion is no longer detected, fixture remains at 100 % for hold time.
4. After pre-set hold time period it will dim to standby dimming level again and always keep it.
5. With sufficient ambient brightness, sensor will turn OFF light automatically.

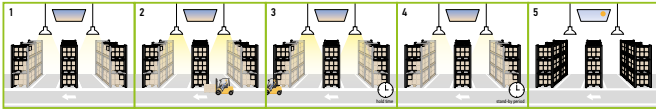

WITH DAYLIGHT DISABLED:

1. Sensor turns ON light when motion is detected.
2. Light will stay on after detecting motion for the desired hold time.
3. Sensor dims light to standby dimming level after hold time if there is still no motion.
4. Sensor turns OFF light after standby period.

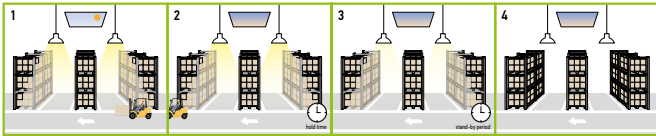

WITH DAYLIGHT THRESHOLD:

1. With sufficient daylight, the light remains OFF even after motion is detected.
2. With insufficient daylight, the sensor turns light ON when motion is detected.
3. After there's no motion detected, the sensor keeps light ON 100 % for holdtime.
4. After holdtime, sensor dims light to standby dimming level for standby period. If the standby period has been set as 0s, sensor turns light OFF automatically after holdtime.
5. The sensor turns OFF light automatically after the standby period when there's no motion detected.

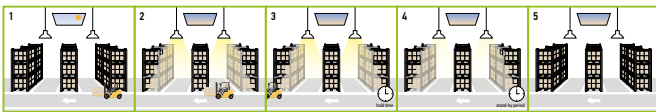

DAYLIGHT HARVESTING:

1. When ambient brightness is lower than preset lux level, sensor will turn on light automatically and keep dimming according to the change of the ambient brightness. As it gets darker outside the fixtures will brighten, and as it gets brighter outside the fixtures will dim down.
2. When the ambient brightness exceeds the preset lux level, the light will turn OFF.

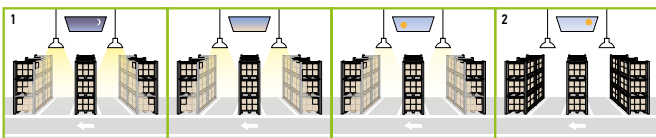

MICROWAVE MOTION SENSOR:

To avoid blocking the microwave emission, the microwave sensor can not be covered with metal materials, be sprayed with a coating of metal components, or have attached metal material or stickers etc.

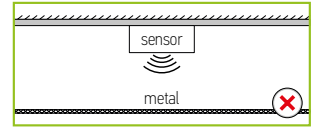

The distance between the antenna and the glass (dielectric material) should be no less than 0.4 ft when the sensor is within the glass lampshade. Otherwise, the microwave motion sensor will not penetrate the glass easily.

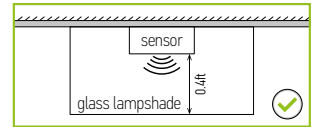

Avoid placing the sensor inside a metal chamber, this may cause a mis-trigger.

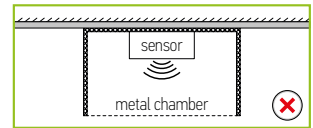

The sensor should not be placed in a small confined space. To avoid increasing the sensor detection range or abnormal operation, the sensor should be kept away from large areas of metal and glass reflectors (separation distance at least 3.3 ft). Reduce the detection area setting.

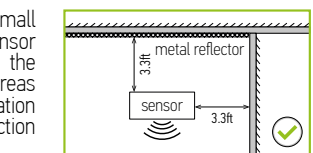

To avoid affecting the microwave signal transmission, the microwave antenna should be higher than the surrounding metal surface.

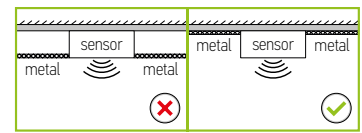

Any vibration or movement may trigger the sensor. Ensure the sensor is far from any constant movement.

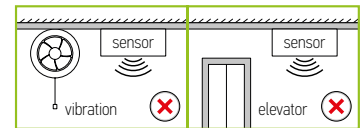

There must be at least 6.5ft between microwave sensors; There must be at least 4.9ft between the sensor and other wireless devices such as routers to avoid possible radio interference.

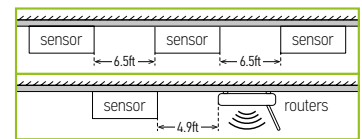

DAYLIGHT HARVESTING SETTING:

1. Adjust "daylight" value higher than 50lux.
2. Preset "standby period" 0S
3. Press MW/PIR button 3 times until the MW/PIR icons are both blinking on LCD screen, daylight harvesting function enabled. (With BLE version, press DH button, daylight harvesting function enabled).

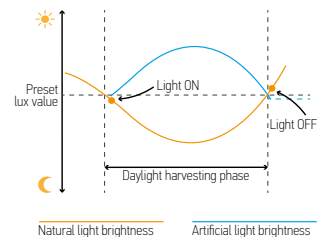



LED UFO HIGH BAY WITH Q-BASE

BATTERY BACK-UP KIT INFORMATION

BLD-RM40R BLD-RM60R sold separately:

BLD-RM40R, BLD-RM60R listed for field and factory installation, provides constant power output to the load during emergency mode operation. They maintain illumination in emergency mode for a minimum of 90 minutes. It is an ideal emergency solution for UFO LED highbay lights.

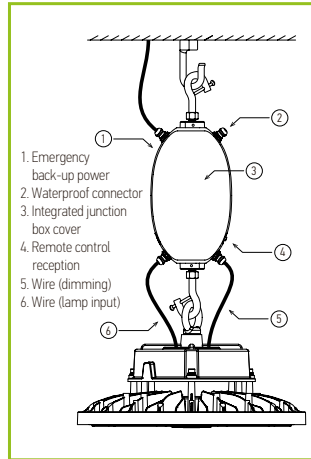

BLD-GM60R-HV sold separately:

BLD-GM60R-HV listed for field and factory installation, provides constant power output to the load during emergency mode operation. It maintains illumination in emergency mode for a minimum of 90 minutes. It is an ideal emergency solution for UFO LED highbay lights.

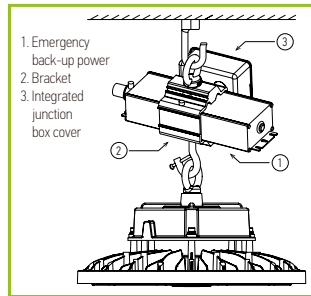
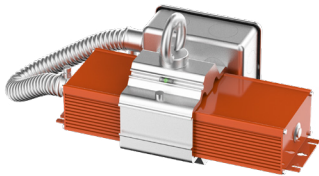

Specifications	BLD-RM40R	BLD-RM60R	BLD-GM60R-HV
Input voltage	100-347 V		277-480 V
Input current	≤ 200 mA		max 100 mA
Input power	max 15W		max 20W
Standby input power	< 0.8W (finished charging)		< 6W (finished charging)
Maximum standby time between recharges	6 months		
Driver type	Constant power		
Output power (emergency mode)	40W	60W	
Output voltage range	≤ 170 Vdc		400 Vdc
Lumens	6,000 lm		
Maximum load power	300W (when dimming to a minimum, the power needs to be less than 36W)		
Peak output power (emergency mode)	100W (lasts for 10 seconds)		65W
Number of output channels	1 channel		
RFI/EMI	FCC part 15 class B		
Output type	LED class 1		
Battery type	Li-ion		
Battery capacity available	2600 mAh (96 WH)		4000 mAh (115 WH)
Battery recharge time	24 hours		
Battery discharge time	90 min		
Maximum lighting fixture weight	44.1 lbs (20 kg)		44.1 lbs (20 kg)
Self-diagnostic test system	<p>In the normal charging mode, the system performs a self-diagnostic test every 30 days, the system switches to emergency mode for 30S, and then automatically switches back to the normal charging mode.</p> <p>In the normal charging mode, the system switches to emergency mode every 360 days (after 11 monthly self-diagnostic test) and works until the end of discharge. Automatically switches back to normal charging mode after discharge.</p>		
Operating temperature	-32°F to 122°F (0°C to 50°C)		40°F to 122°F (5°C to 50°C)
Service life	50,000 hours		
Input surge protection	2 kV		
Protections	Battery over discharge protection, output short circuit protection		
Approvals/class	RoHS, UL924 listed, CEC title 20 Dry/Wet Locations, IP65		

STANDARD OPERATION DISPLAY STATUS:

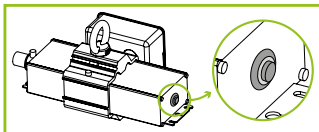

Charging	
Emergency mode	

AC operation: AC power is present. The AC driver operates the LED load as designed. The emergency driver is charging in standby mode. The charging indicator will be lit, showing that the battery is charging.

Emergency operation: When the AC power goes out, the emergency driver detects the AC power outage and automatically switches to emergency mode. When red LED light is OFF, that means driver is discharging. When the AC power is restored, the emergency driver goes back to AC power and starts recharging.

REMOTE TEST SWITCH

RN1 sold separately:

- ▶ Press the ON button to switch battery to the back-up mode. The indicator light will turn off and fixture will decrease light output.
- ▶ Press OFF to switch the fixture to normal operation mode.



For most up-to-date spec sheets please refer to asd-lighting.com



LED UFO HIGH BAY WITH Q-BASE

INSTALLATION GUIDE

IMPORTANT SAFETY INFORMATION:

Please read all the instructions below before installation.

- ▶ Make sure that the supply voltage corresponds to the rated product voltage.
- ▶ The product must be installed by a qualified electrician in accordance with the National Electrical Code and corresponding local codes.
- ▶ If the product is damaged, do not use it.

ELECTRICAL SCHEMATIC DIAGRAM:

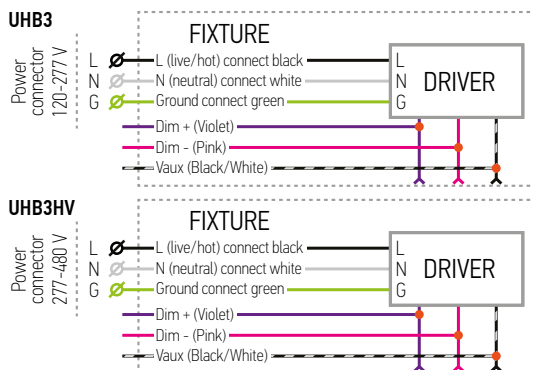

- Note:**
- ▶ The dimmer can also be replaced by an active 1-10 V voltage source signal or passive components like resistors and zener diodes.
 - ▶ Do NOT connect Dim - to be output V - or V +, the driver will not function properly.
 - ▶ If 1-10 V dimming is not used, Dim+ should be open.
 - ▶ When 1-10 V negative logic dimming mode and Dim+ is open, the driver will output minimum current.

UHB3 with motion sensor

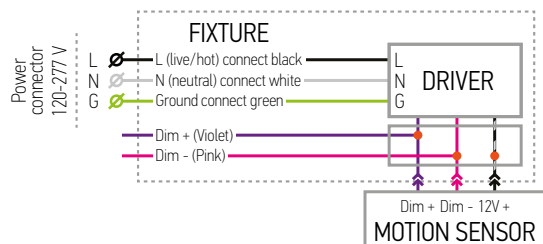

⚠ WARNING

RISK OF PERSONAL INJURY – READ and follow all WARNINGS and installation instructions. Keep or give to the owner for future reference.

Risk of cuts: Wear gloves to prevent cuts or abrasions when removing from carton, handling, installing, and maintaining this product.

Risk of electric shock: This product must be installed in accordance with the applicable installation code by a person familiar with the construction and operation of the product and the hazards involved.

Risk of Fire: Minimum 194°F supply conductors. Consult a qualified electrician to ensure correct branch circuit conductor.

ASD® assumes no responsibility for claims arising out of improper or careless installation or handling of this product.

UHB3 with battery back-up kit

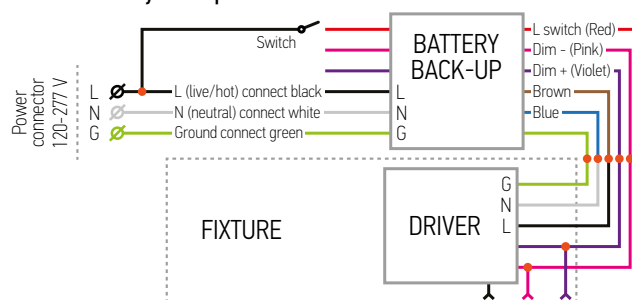

UHB3HV with battery back-up kit

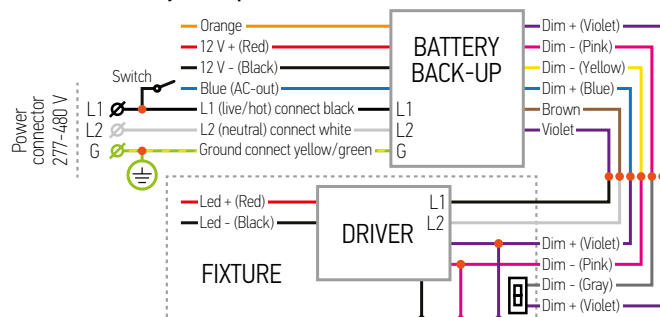

For most up-to-date spec sheets please refer to asd-lighting.com



LED UFO HIGH BAY WITH Q-BASE

INSTALLATION STEPS:

1. Screw on the mounting ring (included) and tighten it. Open rubber caps on the middle of the lens, take off caps inside and adjust color temperature or/and power by simple switch.
2. Clip the fixture on the hook in the ceiling using the mounting ring.
3. Connect the wires: Black to Black, White to White, Green to Green. Secure the connection with wire nuts.

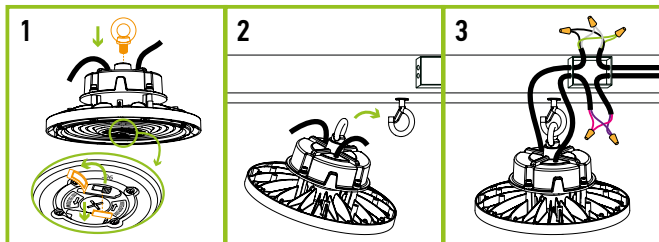

PENDANT MOUNT BRACKET INSTALLATION

ASD-PMB-UHB sold separately:

1. Remove the original ring from the driver.
2. Install the bracket and secure it to the driver using a M10 or M12 screw (included with the bracket).
3. Screw the bracket with the fixture onto a pole and secure it with an M3 screw (included with the bracket).

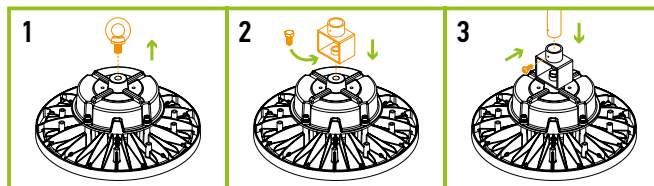

SURFACE MOUNT BRACKET INSTALLATION

ASD-SMB1-UHB3 **ASD-SMB2-UHB3**

sold separately:

1. Use four M5x9/16" screws (included) to install bracket swivel on the top of the fixture's body.
2. Use two M6x5/8" screws (included) to secure bracket on the swivels.
3. Adjust the light direction and secure it using two M5x9/16" screws with screw-nuts (included).

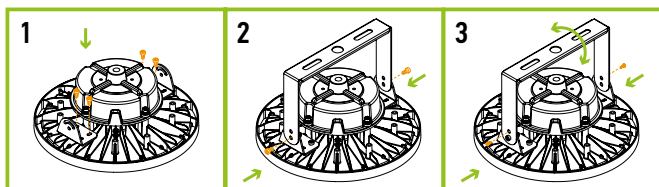

PENDANT MOUNT BRACKET WITH J-BOX AND SPRING HOOK INSTALLATION

ASD-PMBJB-UHB sold separately:

1. Uninstall the mounting ring from the fixture. Unscrew 2 screws and open the side plate on the Pendant Junction box. Install M10 or M12 Mounting screw depending of the fixture's thread size.
2. **Mounting hook installation:** Loosen security screw and install the spring hook into the upper installation hole of the Pendant J-box and secure it with screw. Secure Pendant J-box to the fixture, and then secure to the ceiling. Close and secure side plate back into place.
3. **Pendant installation:** Uninstall adapter from pole mounting hole. Secure the Pendant J-box and fixture to the pole. Secure fixture to the Pendant J-box. Close and secure side plate back into place.

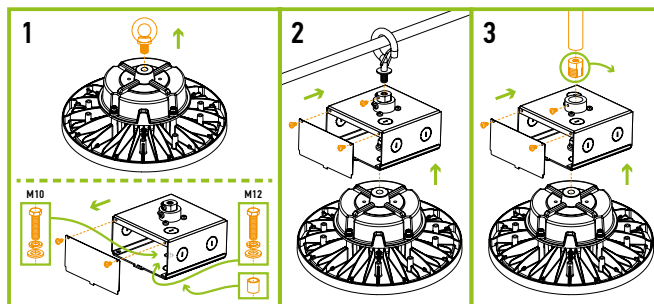

MOTION SENSOR INSTALLATION

ASD-09MW **ASD-09MW-NLS**

ASD-09IR **ASD-09IR-NLS**

sold separately:

1. Unscrew the microwave sensor base cap.
2. Insert and twist the sensor until it is tight on the base surface. FOR ASD-09-NLS sensors download ASD NLS APP using QR codes and add the fixture to it according to the manual.

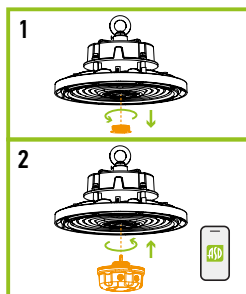

For ASD NLS sensors please download [link link](#) or QR-code below.



ASD NLS APP DOWNLOAD:

Android



IOS



For most up-to-date spec sheets please refer to asd-lighting.com



LED UFO HIGH BAY WITH Q-BASE

BATTERY BACK-UP KIT INSTALLATION

BLD-RM40R **BLD-RM60R** sold separately:

1. Install the G-hook to the top thread hole of the battery back-up and secure with the screw. Attach the battery back-up with G-hook to the ceiling hook.
2. Loosen the screw on the enclosed hook on the bottom of the emergency back-up, attach the ring on the fixture to the hook and tighten screw back. Open the cover and remove the plastic covers and install the five waterproof connectors.
3. Pull all wires through the waterproof connectors into the chamber of emergency driver. Connect wires: Brown, Blue, Green with AC input wires of the fixture. Connect dimming wires Purple and Pink with LED driver input dimming wires. Connect Black, White and Red wires of the battery back-up with AC main Power cord. Secure connection with wire nuts and lock up the cover of junction box.

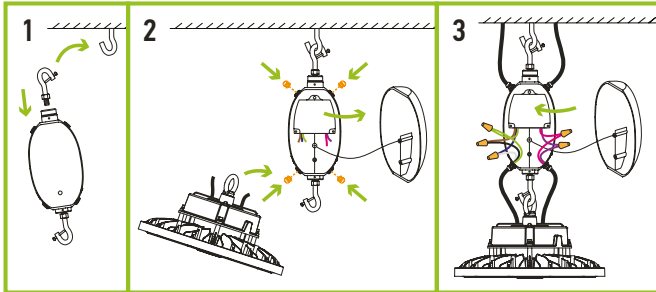

BATTERY BACK-UP KIT INSTALLATION

BLD-GM60R-HV sold separately:

1. Insert battery back-up into the bracket and secure it with three screws. Attach junction box to the side of the bracket with two screws. Screw in mounting ring to the top and mounting hook to the bottom of the bracket. Secure them by 45° angle.
2. Attach bracket with battery to the ceiling using mounting ring. Attach lighting fixture to the mounting hook on the bottom of the bracket and secure it with screw.
3. Plug the fixture's power cable and circuit cable into the junction box. Wire according to the wiring diagram inside the junction box. Close junction box with cover and secure it with two screws.

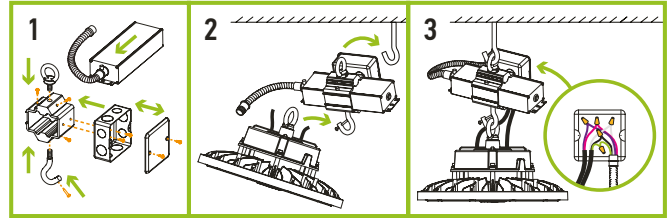

ORDERING INFORMATION

Model	Pcs. per carton	Carton size	Carton weight	UPC
ASD-UHB3-100DAC-BK	1	11" x 11" x 5.8"	6.6 lbs	810050738446
ASD-UHB3-100ADAC-BK	1	11" x 11" x 5.8"	6.6 lbs	810128111294
ASD-UHB3-150DAC-BK	1	11" x 11" x 5.8"	6.6 lbs	810050738453
ASD-UHB3-150ADAC-WH	1	11" x 11" x 5.8"	6.6 lbs	810128111300
ASD-UHB3-150ADAC-BK	1	11" x 11" x 5.8"	6.6 lbs	810128110433
ASD-UHB3-200ADAC-WH	1	13.4" x 13.4" x 6.2"	9 lbs	810128111317
ASD-UHB3-200ADAC-BK	1	13.4" x 13.4" x 6.2"	9 lbs	810050737371
ASD-UHB3-240DAC-BK	1	13.4" x 13.4" x 6.2"	9 lbs	810050738477
ASD-UHB3-240ADAC-BK	1	13.4" x 13.4" x 6.2"	9 lbs	810128111324
ASD-UHB3-300DAC-BK	1	13.4" x 13.4" x 7.3"	13 lbs	810128110204
ASD-UHB3-300ADAC-BK	1	13.4" x 13.4" x 7.3"	12.3 lbs	810128111782
ASD-UHB3-400D50-BK	1	18.7" x 18.7" x 8.4"	20.1 lbs	810050739924
ASD-UHB3-500D50-BK	1	18.7" x 18.7" x 8.4"	20.1 lbs	810050739931
ASD-UHB3-500ADAC-BK	1	18.7" x 18.7" x 8.4"	20.1 lbs	810128111096
UHB3HV HIGH VOLTAGE				
ASD-UHB3HV-150D50-BK	1	11" x 11" x 5.8"	7.3 lbs	810050739900
ASD-UHB3HV-200D50-BK	1	13.4" x 13.4" x 6.2"	11.5 lbs	810050739917
ASD-UHB3HV-300ADAC-BK	1	13.4" x 13.4" x 7.3"	13 lbs	810128110440
ASD-UHB3HV-400D50-BK	1	18.7" x 18.7" x 9.5"	25.2 lbs	810050739948
ASD-UHB3HV-500D50-BK	1	18.7" x 18.7" x 9.5"	25.2 lbs	810050739955
ASD-UHB3HV-500ADAC-BK	1	18.7" x 18.7" x 9.5"	25.1 lbs	810128111102

For most up-to-date spec sheets please refer to asd-lighting.com

ASD LIGHTING CORP

E-mail: orders@asd-lighting.com | Web site: www.asd-lighting.com





LED UFO HIGH BAY WITH Q-BASE

ACCESSORIES:

Model	Description	UPC	Pcs. in middle box	Middle box size	Middle box weight	GTIN 14 in middle box	Pcs. per carton	Carton size	Carton weight	GTIN 14
ASD-09MW-WH	Microwave motion sensor 3pin white	810128113700	10	5.5' x 2.6' x 11.4'	1.2 lbs	20810128113704	120	17.3' x 11.8' x 11"	12.1 lbs	30810128113701
ASD-09MW-BK	Microwave motion sensor 3pin black	810128113717	10	5.5' x 2.6' x 11.4'	1.2 lbs	20810128113711	120	17.3' x 11.8' x 11"	12.1 lbs	30810128113718
ASD-09IR-WH	Infrared motion sensor 3pin white	810128113694	10	5.5' x 2.6' x 11.4'	1.2 lbs	20810128113698	120	17.3' x 11.8' x 11"	12.1 lbs	30810128113695
ASD-09IR-BK	Infrared motion sensor 3pin black	810128114349	10	5.5' x 2.6' x 11.4'	1.2 lbs	20810128114343	120	17.3' x 11.8' x 11"	12.1 lbs	30810128114340
ASD-06RC	Remote control for motion sensor	810128114370	10	6.3' x 2.9' x 11.4'	0.5 lbs	30810128114371	60	15.8' x 11.8' x 9.3'	24.7 lbs	40810128114378
ASD-09MW-NLS-WH	Microwave motion sensor smart 3pin white	810128113762	10	5.5' x 2.6' x 11.4'	1.2 lbs	20810128113766	120	17.3' x 11.8' x 11"	12.1 lbs	30810128113763
ASD-09IR-NLS-WH	Infrared motion sensor smart 3pin white	810128113755	10	5.5' x 2.6' x 11.4'	1.2 lbs	20810128113759	120	17.3' x 11.8' x 11"	12.1 lbs	30810128113756
ASD-06RC-NLS	Remote control for motion sensor smart	810128114387	10	6.3' x 2.9' x 11.4'	0.5 lbs	20810128114381	60	15.8' x 11.8' x 9.3'	24.7 lbs	30810128114388
BLD-RM40R	Battery back-up kit 40W	810050738507	-	-	-	-	4	23.6' x 13.8' x 7.9'	32.5 lbs	20810050738501
BLD-RM60R	Battery back-up kit 60W	810128112154	-	-	-	-	4	23.6' x 13.8' x 7.9'	37.7 lbs	20810128112158
BLD-GM60R-HV	Battery back-up kit 60W for 277-480V	810128112147	-	-	-	-	5	20.5' x 10.8' x 16.7'	41.9 lbs	10810128112144
RN1	Remote test switch for battery back-up kit	810050735223	-	-	-	-	50	13' x 9.8' x 6.5'	8.3 lbs	20810050735227
ASD-H-M10	Spring hook M10	819201025312	-	-	-	-	50	12.6' x 7.7' x 6.9'	12.1 lbs	20819201025316
ASD-H-M12	Spring hook M12	810050730556	-	-	-	-	50	12.6' x 7.7' x 6.9'	17.6 lbs	10810050730553
ASD-HS-M10	Screw-bolt hook M10	810050731164	-	-	-	-	50	11.9' x 8.3' x 9.1'	12.6 lbs	10810050731161
ASD-PMB-UHB	Pendant mount bracket	810050731522	-	-	-	-	50	13.9' x 9.7' x 7.1'	33.7 lbs	10810050731529
ASD-PMBJB-UHB	Pendant mount bracket with J-box and spring hook	810050736992	-	-	-	-	20	17.2' x 11.3' x 11.2'	30.9 lbs	10810050736999
ASD-SMB1-UHB3-WH	Surface mount bracket white for 100-300W	810128111652	-	-	-	-	20	22.1' x 14.6' x 16.5'	32 lbs	10810128111659
ASD-SMB1-UHB3-BK	Surface mount bracket black for 100-300W	810050739818	-	-	-	-	20	22.1' x 14.6' x 16.5'	32 lbs	10810050739815
ASD-SMB2-UHB3-BK	Surface mount bracket black for 400-500W	810128110785	-	-	-	-	20	26' x 17.7' x 15.4'	59.5 lbs	10810128110782

ANNEX 1

Model	Watts	3,000 K	4,000 K	5,000 K
ASD-UHB3-100DAC-BK	100W	14,500 lm	15,017 lm	14,603 lm
ASD-UHB3-100ADAC-BK	60W	8,852 lm	9,527 lm	9,559 lm
	80W	11,598 lm	12,591 lm	12,355 lm
	100W	13,766 lm	15,018 lm	14,604 lm
ASD-UHB3-150DAC-BK	150W	21,750 lm	22,570 lm	22,437 lm
ASD-UHB3-150ADAC-WH ASD-UHB3-150ADAC-BK	100W	15,131 lm	15,946 lm	15,975 lm
	120W	17,927 lm	18,981 lm	18,616 lm
	150W	21,750 lm	22,047 lm	21,521 lm
ASD-UHB3-200ADAC-WH ASD-UHB3-200ADAC-BK	100W	15,790 lm	16,362 lm	16,255 lm
	150W	23,080 lm	24,123 lm	23,469 lm
	200W	28,726 lm	31,495 lm	30,407 lm
ASD-UHB3-240DAC-BK	240W	34,800 lm	37,169 lm	39,678 lm
ASD-UHB3-240ADAC-BK	150W	22,261 lm	23,957 lm	24,542 lm
	200W	28,559 lm	31,092 lm	31,244 lm
	240W	34,800 lm	36,446 lm	34,564 lm
ASD-UHB3-300DAC-BK	300W	41,282 lm	44,960 lm	43,017 lm
ASD-UHB3-300ADAC-BK	200W	28,054 lm	30,666 lm	30,978 lm
	240W	32,618 lm	35,695 lm	35,304 lm
	300W	41,429 lm	41,507 lm	40,913 lm
ASD-UHB3-400D50-BK	400W	-	-	58,725 lm
ASD-UHB3-500D50-BK	500W	-	-	72,413 lm
ASD-UHB3-500ADAC-BK	300W	46,690 lm	48,589 lm	47,548 lm
	400W	57,786 lm	61,400 lm	59,570 lm
	500W	69,357 lm	72,911 lm	69,777 lm
ASD-UHB3HV-150D50-BK	150W	-	-	22,200 lm
ASD-UHB3HV-200D50-BK	200W	-	-	29,600 lm
ASD-UHB3HV-300ADAC-BK	200W	26,842 lm	28,601 lm	28,531 lm
	240W	31,666 lm	33,708 lm	32,942 lm
	300W	42,244 lm	40,094 lm	39,043 lm
ASD-UHB3HV-400D50-BK	400W	-	-	58,651 lm
ASD-UHB3HV-500D50-BK	500W	-	-	70,425 lm
ASD-UHB3HV-500ADAC-BK	300W	46,360 lm	48,503 lm	47,247 lm
	400W	59,758 lm	62,712 lm	59,702 lm
	500W	69,734 lm	74,808 lm	70,716 lm

For most up-to-date spec sheets please refer to asd-lighting.com