



LED UFO HIGH BAY

Standard and Premium Series

► **DESIGN & OPTIONS** - LED UFO HIGH BAY LIGHTS are extremely efficient with a 130-150 lm/W output and are equipped with 0-10V dimmable drivers. Die-cast aluminum housing also provides excellent heat dissipation. You can choose either 120-277V or 200-480V with a 3500K, 4000K or 5000K color temperature. Additional options include: motion sensor kit for higher energy savings, battery back-up with 90 min of power, and different types of reflectors and lenses (sold separately). Comes with a BLACK or WHITE finish.

► **INSTALLATION** - This fixture has three different mounting options: suspended, surface, and pendant. It can easily be suspended from the ceiling with the included hanging ring. Surface and pendant mount brackets are also available (sold separately). Refer to install instructions for detailed steps.

► **APPLICATION** - These lights are the perfect commercial or industrial solution for warehouses, supermarkets, retail stores, gyms, garages, general task areas, and many other applications. This fixture is Wet location rated and IP69K certified and is resistant to high pressure, temperature, water, and dust. These LED UFO HIGH BAY LIGHTS can operate in temperatures between -40+149°F (-40+65°C), allowing them to be utilized in a wide variety of applications and climates.

► **ENERGY SAVING & EFFICIENCY** - This fixture provides a lumen output equal to MH/HPS and can cut your electric bill by up to 80% instantly. With a lifespan of 54,000 hours, these fixtures are made to last decades under normal operation! This fixture will save you a significant amount of money in its lifetime.

► **CERTIFICATION & WARRANTY** - Buy with confidence: ASD provides a 5-year warranty along with UL and DLC Premium and Standard certifications to guarantee top quality products and safety!

Top US certifications allow participation in rebates; please check the rebate programs available in your state.

Catalog number	
Notes	
Type	

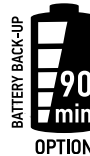

Finish: Black White

PRODUCT LEGEND:

Family	Modification	Voltage	Watts	Dimmable	CCT	Finish	Series
ASD-UHB	2	XX	XXX	D	XX	X	XXX
LED UFO High Bay		Blank = Regular HV = High Voltage	100 = 100 W 150 = 150 W 200 = 200 W	240 = 240 W 300 = 300 W	Dimmable	35 = 3,500 K 40 = 4,000 K 50 = 5,000 K	Blank = Black W = White STD = Standard PRM = Premium

LED UFO HIGH BAY FIXTURE:

Model	Watts	Voltage	Dimming	Lumens	CCT	Finish	Dimensions (LxWxH)	Cord
ASD-UHB2-100D35-STD	100 W	120-277 V	1-10 V	13,175 lm	3,500 K	Black	10 1/4" x 10 1/4" x 5 1/16"	4 ft
ASD-UHB2-150D35-STD	150 W	120-277 V	1-10 V	19,419 lm	3,500 K	Black	10 1/4" x 10 1/4" x 5 1/16"	4 ft
ASD-UHB2-200D35-STD	200 W	120-277 V	1-10 V	26,041 lm	3,500 K	Black	10 1/4" x 10 1/4" x 5 15/16"	4 ft
ASD-UHB2-100D40W-PRM	100 W	120-277 V	1-10 V	13,765 lm	4,000 K	White	10 1/4" x 10 1/4" x 5 5/16"	4 ft
ASD-UHB2-100D50-PRM	100 W	120-277 V	1-10 V	14,203 lm	5,000 K	Black	10 1/4" x 10 1/4" x 5 5/16"	4 ft
ASD-UHB2-100D50W-PRM	100 W	120-277 V	1-10 V	14,203 lm	5,000 K	White	10 1/4" x 10 1/4" x 5 5/16"	4 ft
ASD-UHB2-150D40W-PRM	150 W	120-277 V	1-10 V	20,321 lm	4,000 K	White	10 1/4" x 10 1/4" x 5 5/16"	4 ft
ASD-UHB2-150D50-PRM	150 W	120-277 V	1-10 V	21,928 lm	5,000 K	Black	10 1/4" x 10 1/4" x 5 5/16"	4 ft
ASD-UHB2-150D50W-PRM	150 W	120-277 V	1-10 V	21,928 lm	5,000 K	White	10 1/4" x 10 1/4" x 5 5/16"	4 ft
ASD-UHB2-200D40W-PRM	200 W	120-277 V	1-10 V	26,560 lm	4,000 K	White	10 1/4" x 10 1/4" x 5 15/16"	4 ft
ASD-UHB2-200D50-PRM	200 W	120-277 V	1-10 V	27,333 lm	5,000 K	Black	10 1/4" x 10 1/4" x 5 15/16"	4 ft
ASD-UHB2-200D50W-PRM	200 W	120-277 V	1-10 V	27,333 lm	5,000 K	White	10 1/4" x 10 1/4" x 5 15/16"	4 ft
ASD-UHB2-240D50-PRM	240 W	120-277 V	1-10 V	35,623 lm	5,000 K	Black	12 5/8" x 12 5/8" x 5 5/8"	4 ft
ASD-UHB2-300D50-PRM	300 W	120-277 V	1-10 V	30,138 lm	5,000 K	Black	12 5/8" x 12 5/8" x 6 3/16"	4 ft
ASD-UHB2HV-100D50-PRM	100 W	200-480 V	0-10 V	13,615 lm	5,000 K	Black	10 1/4" x 10 1/4" x 5 5/16"	4 ft
ASD-UHB2HV-150D50-PRM	150 W	200-480 V	0-10 V	19,875 lm	5,000 K	Black	10 1/4" x 10 1/4" x 5 5/16"	4 ft
ASD-UHB2HV-200D50-PRM	200 W	200-480 V	0-10 V	27,607 lm	5,000 K	Black	10 1/4" x 10 1/4" x 6 5/16"	4 ft
ASD-UHB2HV-240D50-PRM	240 W	200-480 V	0-10 V	32,714 lm	5,000 K	Black	12 5/8" x 12 5/8" x 5 3/4"	4 ft

For most up-to-date spec sheets please refer to asd-lighting.com

ASD LIGHTING CORP

E-mail: orders@asd-lighting.com | Web site: www.asd-lighting.com





LED UFO HIGH BAY

Standard and Premium Series

PRODUCT SPECIFICATIONS:

Construction & Materials										
Housing	Die cast Aluminum									
Finish	Black, White									
Weight	ASD-UHB2-100D35-STD	6 lb (2.7 kg)	ASD-UHB2-100D40W-PRM	6 lb (2.7 kg)	ASD-UHB2-200D40W-PRM	7.1 lb (3.2 kg)	ASD-UHB2HV-100D50-PRM	6 lb (2.7 kg)	ASD-UHB2HV-150D50-PRM	6.6 lb (3 kg)
	ASD-UHB2-150D35-STD		ASD-UHB2-100D50-PRM		ASD-UHB2-200D50-PRM		ASD-UHB2HV-200D50-PRM			
	ASD-UHB2-200D35-STD	7.1 lb (3.2 kg)	ASD-UHB2-100D50W-PRM		ASD-UHB2-240D50-PRM	8.4 lb (3.8 kg)	ASD-UHB2HV-240D50-PRM	8.4 lb (3.8 kg)		
			ASD-UHB2-150D40W-PRM		ASD-UHB2-300D50-PRM	15 lb (6.8 kg)				
			ASD-UHB2-150D50-PRM							
			ASD-UHB2-150D50W-PRM							
Environmental System										
Work Environment	Suitable for Wet Locations, IP65/69K									
Operating Temperature	-40°F to 149°F / -40°C to 65°C *									
L-70 Life	R > 54,000 hrs; C > 145,000 hrs									
Optical System										
Luminous Flux	ASD-UHB2-100D35-STD	13,175 lm	ASD-UHB2-100D40W-PRM	13,765 lm	ASD-UHB2-200D40W-PRM	26,560 lm	ASD-UHB2HV-100D50-PRM	13,615 lm		
	ASD-UHB2-150D35-STD	19,419 lm	ASD-UHB2-100D50-PRM	14,203 lm	ASD-UHB2-200D50-PRM	27,333 lm	ASD-UHB2HV-150D50-PRM	19,875 lm		
	ASD-UHB2-200D35-STD	26,041 lm	ASD-UHB2-100D50W-PRM		ASD-UHB2-240D50-PRM	35,623 lm	ASD-UHB2HV-200D50-PRM	27,607 lm		
			ASD-UHB2-150D40W-PRM	20,321 lm	ASD-UHB2-300D50-PRM	30,138 lm	ASD-UHB2HV-240D50-PRM	32,714 lm		
			ASD-UHB2-150D50-PRM	21,928 lm						
			ASD-UHB2-150D50W-PRM							
Color Temperature	3,500 K; 4,000 K; 5,000 K									
CRI	> 80									
Electrical System										
Input Voltage	Regular Voltage 120-277 V						High Voltage 200-480VAC			
Max input current	ASD-UHB2-100D35-STD	1.44 A	ASD-UHB2-100D40W-PRM	1 A	ASD-UHB2-200D40W-PRM	1.67 A	ASD-UHB2HV-100D50-PRM	0.6 A	ASD-UHB2HV-150D50-PRM	0.9 A
	ASD-UHB2-150D35-STD	1.8 A	ASD-UHB2-100D50-PRM		ASD-UHB2-200D50-PRM		ASD-UHB2HV-200D50-PRM		1.2 A	
	ASD-UHB2-200D35-STD	2.4 A	ASD-UHB2-100D50W-PRM		ASD-UHB2-240D50-PRM		ASD-UHB2HV-240D50-PRM		1.2 A	
			ASD-UHB2-150D40W-PRM	1.25 A	ASD-UHB2-150D50-PRM	2.88 A				
			ASD-UHB2-150D50W-PRM		ASD-UHB2-300D50-PRM		3.6 A			
Inrush current (Action time)	ASD-UHB2-100D35-STD	100 A (0.15 S)	ASD-UHB2-100D40W-PRM	100 A (0.15 S)	ASD-UHB2-200D40W-PRM	130 A (0.15 S)	ASD-UHB2HV-100D50-PRM	60 A (0.5 S)	ASD-UHB2HV-150D50-PRM	60 A (0.5 S)
	ASD-UHB2-150D35-STD	130 A (0.15 S)	ASD-UHB2-100D50-PRM		ASD-UHB2-200D50-PRM		ASD-UHB2HV-200D50-PRM			
	ASD-UHB2-200D35-STD		ASD-UHB2-100D50W-PRM		ASD-UHB2-240D50-PRM		ASD-UHB2HV-240D50-PRM			
			ASD-UHB2-150D40W-PRM	130 A (0.15 S)	ASD-UHB2-150D50-PRM	120 A (0.8 S)				
			ASD-UHB2-150D50W-PRM		ASD-UHB2-300D50-PRM					
AC input range	Regular Voltage min 90 V max 305 V						High Voltage min 180 V max 528 V			
Off State Power	0 W									
Power Consumption	ASD-UHB2-100D35-STD	100 W	ASD-UHB2-100D40W-PRM	100 W	ASD-UHB2-200D40W-PRM	200 W	ASD-UHB2HV-100D50-PRM	100 W	ASD-UHB2HV-150D50-PRM	150 W
	ASD-UHB2-150D35-STD	150 W	ASD-UHB2-100D50-PRM		ASD-UHB2-200D50-PRM		ASD-UHB2HV-200D50-PRM		200 W	
	ASD-UHB2-200D35-STD	200 W	ASD-UHB2-100D50W-PRM		ASD-UHB2-240D50-PRM		ASD-UHB2HV-240D50-PRM		240 W	
			ASD-UHB2-150D40W-PRM	150 W	ASD-UHB2-150D50-PRM	300 W				
			ASD-UHB2-150D50W-PRM		ASD-UHB2-300D50-PRM					
Power Factor	> 0.9									
Output voltage	ASD-UHB2-100D35-STD	130 V	ASD-UHB2-100D40W-PRM	130 V	ASD-UHB2-200D40W-PRM	260 V	ASD-UHB2HV-100D50-PRM	58 V	ASD-UHB2HV-150D50-PRM	58 V
	ASD-UHB2-150D35-STD	260 V	ASD-UHB2-100D50-PRM		ASD-UHB2-200D50-PRM		ASD-UHB2HV-200D50-PRM			
	ASD-UHB2-200D35-STD		ASD-UHB2-100D50W-PRM		ASD-UHB2-240D50-PRM		ASD-UHB2HV-240D50-PRM			
			ASD-UHB2-150D40W-PRM	260 V	ASD-UHB2-150D50-PRM	56 V				
			ASD-UHB2-150D50W-PRM		ASD-UHB2-300D50-PRM					
Max output current	ASD-UHB2-100D35-STD	920 mA	ASD-UHB2-100D40W-PRM	920 mA	ASD-UHB2-200D40W-PRM	770 mA	ASD-UHB2HV-100D50-PRM	1.65 A	ASD-UHB2HV-150D50-PRM	2.6 A
	ASD-UHB2-150D35-STD	570 mA	ASD-UHB2-100D50-PRM		ASD-UHB2-200D50-PRM		ASD-UHB2HV-200D50-PRM			
	ASD-UHB2-200D35-STD	770 mA	ASD-UHB2-100D50W-PRM		ASD-UHB2-240D50-PRM		ASD-UHB2HV-240D50-PRM			
			ASD-UHB2-150D40W-PRM	570 mA	ASD-UHB2-150D50-PRM	920 mA				
			ASD-UHB2-150D50W-PRM		ASD-UHB2-300D50-PRM		5.4 A			
LED driver class	ASD-UHB2-100D35-STD	Non-isolated	ASD-UHB2-100D40W-PRM	Non-isolated	ASD-UHB2-200D40W-PRM	Non-isolated	ASD-UHB2HV-100D50-PRM	Class 2	ASD-UHB2HV-150D50-PRM	Isolated
	ASD-UHB2-150D35-STD		ASD-UHB2-100D50-PRM		ASD-UHB2-200D50-PRM		ASD-UHB2HV-200D50-PRM			
	ASD-UHB2-200D35-STD		ASD-UHB2-100D50W-PRM		ASD-UHB2-240D50-PRM		ASD-UHB2HV-240D50-PRM			
		ASD-UHB2-150D40W-PRM	ASD-UHB2-150D50-PRM		ASD-UHB2-300D50-PRM		HL			
			ASD-UHB2-150D50W-PRM							
Dimming compatible controls										
Brand	Leviton		Lutron							
Models	Z5057-DOZ	IP710	DVTV	DVSTV						
	DS710	DD710	NTSTV	MS-Z101						
Regular and Voluntary Certifications										
5-year limited warranty										
cULus listed E473804										
DesignLights Consortium (DLC) listed (Classification: Standard and Premium series)										
Main: Indoor Luminaires; General Application: High-Bay;										
Primary Use: High-Bay Luminaires for Commercial and Industrial Buildings										

* Under extreme conditions fixture may enter protection mode. If ambient temperature exceeds 65°C (149°F) for an extended period lumen output will decrease to 60% capacity. At higher sustained temperatures protection mode will terminate power to the fixture.

PACKAGE CONTENTS:

Description	Q-ty
LED UFO High Bay Fixture	1
Mounting ring (A)	1
Safety cable (B)	1
Box	1
Cut sheet	2

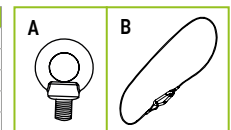





For most up-to-date spec sheets please refer to asd-lighting.com

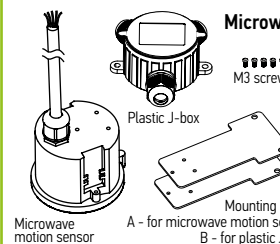

LED UFO HIGH BAY

Standard and Premium Series

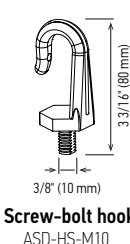
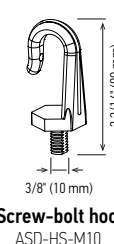
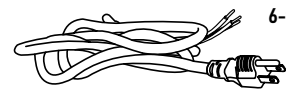
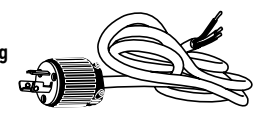
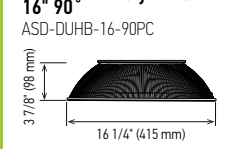
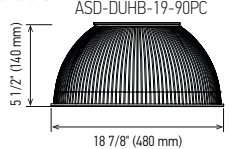
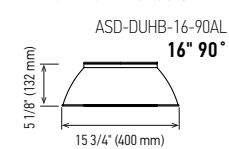
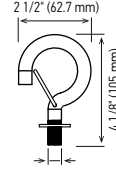
ACCESSORIES (sold separately):

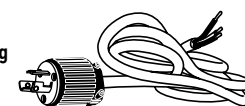
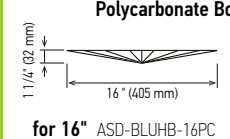
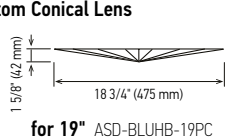
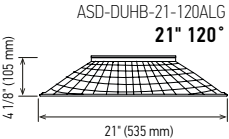
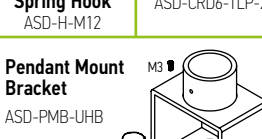
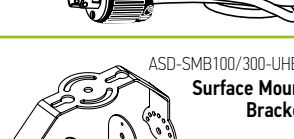
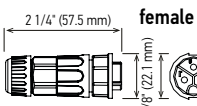
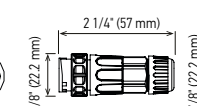
 <p>Microwave motion sensor kit</p> <p>for regular voltage UHB-MSK1</p> <p>for high voltage UHBHV-MSK2</p> <p>M3 screws, Wiring cap, M4 screws</p> <p>Plastic J-box, Mounting plate: A - for microwave motion sensor, B - for plastic J-box</p>	 <p>Remote Control for UHB-MSK1</p> <p>UHB-RC-MSK1</p>  <p>Remote Control for UHBHV-MSK2</p> <p>ASD-CELP02H-MS</p>	 <p>2 1/8" (55 mm) 3 1/2" (90 mm) 3/8" (10 mm)</p> <p>Spring Hook ASD-H-M10</p>	 <p>3 3/16" (80 mm) 3/8" (10 mm)</p> <p>Screw-bolt hook ASD-HS-M10</p>	 <p>LED Emergency back-up power supply 40W dimming 0-10V</p> <p>WEP-EWG-040U</p>  <p>EMK-RC</p> <p>Remote test switch for LED Emergency back-up power supply</p>
<p>16" 90° Polycarbonate Reflector ASD-DUHB-16-90PC</p>  <p>3 7/8" (98 mm) 16 1/4" (415 mm)</p> <p>19" 90° Polycarbonate Reflector ASD-DUHB-19-90PC</p>  <p>5 1/2" (140 mm) 18 7/8" (480 mm)</p>	<p>Aluminum Reflector ASD-DUHB-16-90AL</p>  <p>5 1/8" (132 mm) 15 3/4" (400 mm)</p>	 <p>2 1/2" (62.7 mm) 4 1/8" (105 mm) 1/2" (12 mm)</p> <p>Spring Hook ASD-H-M12</p>	<p>6-foot Cord 120V-277V Straight Blade Plug ASD-CRD6-SBP-277V</p>  <p>6-foot Cord 120V-277V 3-Blade Twist-Lock Plug ASD-CRD6-TLP-277V</p> 	
<p>Polycarbonate Bottom Conical Lens</p> <p>for 16" ASD-BLUHB-16PC</p>  <p>1 1/4" (32 mm) 16" (405 mm)</p> <p>for 19" ASD-BLUHB-19PC</p>  <p>1 5/8" (42 mm) 18 3/4" (475 mm)</p>	<p>ASD-DUHB-21-120ALG</p>  <p>4 1/8" (105 mm) 21" (535 mm)</p>	<p>Pendant Mount Bracket ASD-PMB-UHB</p>  <p>M10, M12</p> <p>D 1 1/4" (32 mm) Inner thread 3/4"-14 NPT M3 inner thread</p> <p>2 3/8" (60 mm) 1 15/16" (50 mm) 1 5/8" (40 mm) 2 7/8" (72 mm)</p>	<p>ASD-SMB100/300-UHB2</p>  <p>Surface Mount Bracket</p> <p>9 11/16" (246 mm) 5 5/16" (135 mm)</p> <p>d 4 1/2" (115.35 mm) 119.8° d 2 3/4" (69.66 mm) d 5/8" (18 mm) d 1 1/16" (27.5 mm) d 2 1/4" (57.56 mm)</p>	
<p>Inline Wire Connector LLT-M19CS03 for all fixture models</p> <ul style="list-style-type: none"> M19 screw fixing wire 3 pin male and female waterproof connector IP67 protection level Contact Brass with Gold Plated Current rating: 20A per contact Voltage rating: 250V Accepted Max. Cable OD: 10mm Field installable, Screw fixing with cable  <p>2 1/4" (57.5 mm) female</p>  <p>2 1/4" (57 mm) male</p> <p>7/8" (22.2 mm), 7/8" (22.2 mm)</p> <p>Note: For power wiring ONLY. Do not use for dimmer wires</p>				<p>Emergency back-up power supply WEP-EWG-040U</p> <p>6-foot Cord 120V-277V Straight Blade Plug ASD-CRD6-SBP-277V</p> <p>6-foot Cord 120V-277V 3-Blade Twist-Lock Plug ASD-CRD6-TLP-277V</p> <p>Pendant Mount Bracket ASD-PMB-UHB</p> <p>Surface mount Bracket ASD-SMB100/300-UHB2</p>

ACCESSORIES COMPATIBLE LIST:

Models	Accessories																
	Microwave motion sensor kit UHB-MSK1	Microwave motion sensor kit UHBHV-MSK2	Polycarbonate Reflector 16" ASD-DUHB-16-90PC	Polycarbonate Reflector 19" ASD-DUHB-19-90PC	Polycarbonate Bottom Conical Lens for 16" ASD-BLUHB-16PC	Polycarbonate Bottom Conical Lens for 19" ASD-BLUHB-19PC	Aluminum Reflector 16" ASD-DUHB-16-90AL	Aluminum Reflector 21" ASD-DUHB-21-120ALG	Inline Wire Connector LLT-M19CS03	Spring Hook M10 ASD-H-M10	Screw-bolt hook M10 ASD-HS-M10	Spring Hook M12 ASD-H-M12	Emergency back-up power supply WEP-EWG-040U	6-foot Cord 120V-277V Straight Blade Plug ASD-CRD6-SBP-277V	6-foot Cord 120V-277V 3-Blade Twist-Lock Plug ASD-CRD6-TLP-277V	Pendant Mount Bracket ASD-PMB-UHB	Surface mount Bracket ASD-SMB100/300-UHB2
ASD-UHB2-100D35-STD	•	•	•	•	•	•	•	•	•	•	•	•	•	•	•	•	•
ASD-UHB2-150D35-STD	•	•	•	•	•	•	•	•	•	•	•	•	•	•	•	•	•
ASD-UHB2-200D35-STD	•	•	•	•	•	•	•	•	•	•	•	•	•	•	•	•	•
ASD-UHB2-100D40W-PRM	•	•	•	•	•	•	•	•	•	•	•	•	•	•	•	•	•
ASD-UHB2-100D50-PRM	•	•	•	•	•	•	•	•	•	•	•	•	•	•	•	•	•
ASD-UHB2-100D50W-PRM	•	•	•	•	•	•	•	•	•	•	•	•	•	•	•	•	•
ASD-UHB2-150D40W-PRM	•	•	•	•	•	•	•	•	•	•	•	•	•	•	•	•	•
ASD-UHB2-150D50-PRM	•	•	•	•	•	•	•	•	•	•	•	•	•	•	•	•	•
ASD-UHB2-150D50W-PRM	•	•	•	•	•	•	•	•	•	•	•	•	•	•	•	•	•
ASD-UHB2-200D40W-PRM	•	•	•	•	•	•	•	•	•	•	•	•	•	•	•	•	•
ASD-UHB2-200D50-PRM	•	•	•	•	•	•	•	•	•	•	•	•	•	•	•	•	•
ASD-UHB2-200D50W-PRM	•	•	•	•	•	•	•	•	•	•	•	•	•	•	•	•	•
ASD-UHB2-240D50-PRM	•	•	•	•	•	•	•	•	•	•	•	•	•	•	•	•	•
ASD-UHB2-300D50-PRM	•	•	•	•	•	•	•	•	•	•	•	•	•	•	•	•	•
ASD-UHB2HV-100D50-PRM	•	•	•	•	•	•	•	•	•	•	•	•	•	•	•	•	•
ASD-UHB2HV-150D50-PRM	•	•	•	•	•	•	•	•	•	•	•	•	•	•	•	•	•
ASD-UHB2HV-200D50-PRM	•	•	•	•	•	•	•	•	•	•	•	•	•	•	•	•	•
ASD-UHB2HV-240D50-PRM	•	•	•	•	•	•	•	•	•	•	•	•	•	•	•	•	•

For most up-to-date spec sheets please refer to asd-lighting.com





LED UFO HIGH BAY

Standard and Premium Series

INSTALLATION GUIDE

IMPORTANT SAFETY INFORMATION:

Please read all the instructions below before installation.

- ▶ Make sure that the supply voltage corresponds to the rated product voltage.
- ▶ The product must be installed by a qualified electrician in accordance with the National Electrical Code and corresponding local codes.
- ▶ If the product is damaged, do not use it.

⚠ WARNING

RISK OF PERSONAL INJURY – READ and follow all WARNINGS and installation instructions. Keep or give to the owner for future reference.

Risk of cuts: Wear gloves to prevent cuts or abrasions when removing from carton, handling, installing, and maintaining this product.

Risk of electric shock: This product must be installed in accordance with the applicable installation code by a person familiar with the construction and operation of the product and the hazards involved.

Risk of Fire: Minimum 194°F supply conductors. Consult a qualified electrician to ensure correct branch circuit conductor.

ASD® assumes no responsibility for claims arising out of improper or careless installation or handling of this product.

INSTALLATION STEPS:

1. Screw the Hanging Ring (included) and tighten it.
2. Clip the fixture on the hook in the ceiling using Hanging ring. Secure the luminaire with a safety cable.
3. Connect the wires: Black to Black, White to White, Green to Green. Secure the connection with Wire Nuts.

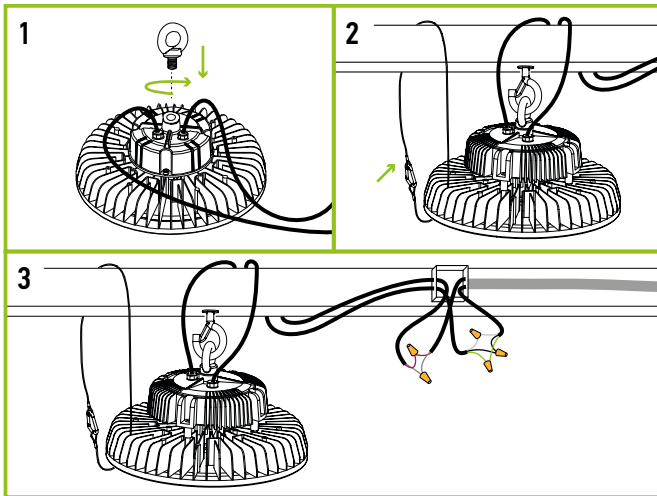

DIFFUSER AND LENS INSTALLATION

sold separately:

1. Install the diffuser, tighten the screws
2. Attach the conical lens to the included clamp

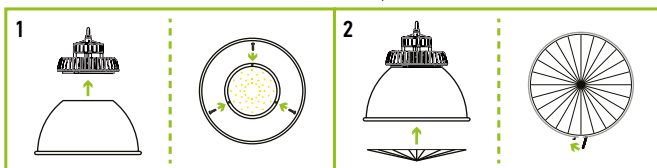

This fixture features Integrated dimming and can be 1-10V, PWM signal or resistance dimming to save energy and achieve specific light levels. The LED UFO High Bay is designed to install as a surface mounted luminaire.

ELECTRICAL SCHEMATIC DIAGRAM:

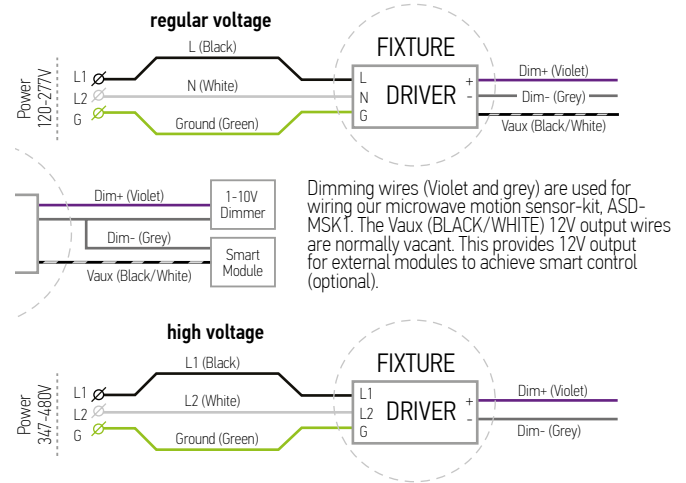

SURFACE MOUNT BRACKET INSTALLATION

ASD-SMB100/300-UHB2 sold separately:

1. Use four PM5x16 mm screws (included) to install bracket swivel on the top of the lamp body.
2. Use two PM5x12 mm screws (include) to fix bracket on the swivels.
3. Adjust the lighting direction and fix it using two M8x20 mm screws (include).

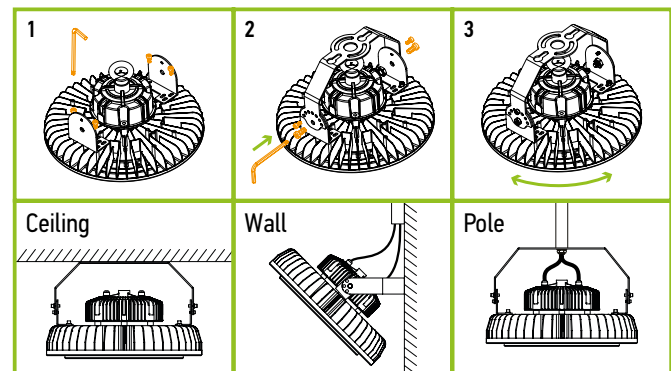

PENDANT MOUNT BRACKET INSTALLATION

ASD-PMB-UHB sold separately:

1. Remove the original ring from the driver.
2. Install the adapter, fix it on the driver using a M10 or M12 screw (included with the adapter).
3. Screw the adapter with the fixture onto a pole, fix the adapter with an M3 screw (included with the adapter).

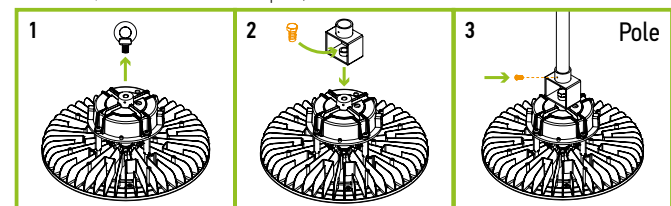

For most up-to-date spec sheets please refer to asd-lighting.com



LED UFO HIGH BAY

Standard and Premium Series

MICROWAVE MOTION SENSOR KIT INFORMATION

- ▶ Sensor parameters can be conveniently set via remote control
- ▶ Mounting height up to 15m max., suitable for warehouse use
- ▶ Water proof sensor with IP65 rating
- ▶ Automatic dimming when used in combination with 1-10V dimmable control gears
- ▶ Built-in adjustable daylight sensor
- ▶ 1-10V interface can match up with Merrytek stand-alone daylight sensor MS01 to achieve daylight harvesting
- ▶ Optional mounting brackets for different applications

Specifications	model UHB-MSK1 (sold separately)			model UHBHV-MSK2 (sold separately)		
For fixture models	ASD-UHB2-100D40W-PRM ASD-UHB2-100D50-PRM ASD-UHB2-100D50W-PRM	ASD-UHB2-150D40W-PRM ASD-UHB2-150D50-PRM ASD-UHB2-150D50W-PRM	ASD-UHB2-200D40W-PRM ASD-UHB2-200D50-PRM ASD-UHB2-200D50W-PRM	ASD-UHB2-240D50-PRM ASD-UHB2-300D50-PRM	ASD-UHB2HV-100D50-PRM ASD-UHB2HV-150D50-PRM	ASD-UHB2HV-200D50-PRM ASD-UHB2HV-240D50-PRM
Rated load	120 Vac - 400 W max; 277 Vac - 800 W max			347 Vac - 800 W max; 480 Vac - 1200 W max		
Detection area	25% / 50% / 75% / 100%					
Hold time	5 s/30 s/1 min/3 min/5 min/10 min/20 min/30 min					
Daylight sensor	5 lux/15 lux/30 lux/50 lux/100 lux/150 lux/Disable			2 lux/10 lux/30 lux/50 lux/80 lux/120 lux/Disable		
Standby period	0 s/10 s/1 min/3 min/5 min/10 min/30 min/+∞					
Standby dimming level	10% / 20% / 30% / 50%					
Sensor principle	Microwave motion detector					
Microwave frequency	5.8 GHz ± 75 MHz, ISM wave band					
Transmitting power	<0.5 mW (1% of transmitting power for cell phone)			<1 mW (1% of transmitting power for cell phone)		
Mounting height	3-15 m (10-50 ft)					
Detection angle	150° (Wall installation); 360° (Ceiling installation)					
Motion detection	0.5-3 m/s					
Operating temperature	-31 to 158°F (-35°C to 70°C)					
IP rating	IP65					

 RF interference may affect the operation of this sensor

INSTALLATION STEPS FIXTURES WITHOUT REFLECTOR

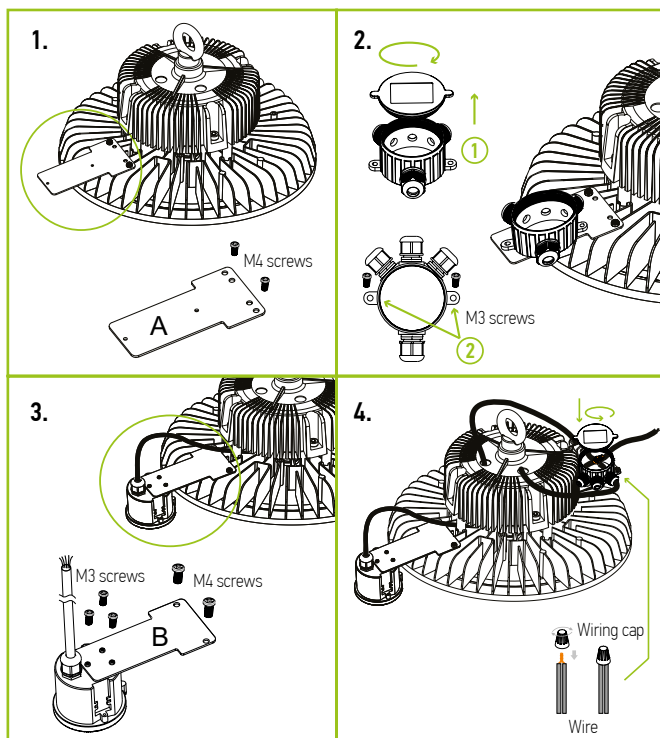

FIXTURES WITH AL REFLECTOR

Note: while using PC reflector or PC reflector + conical lens, the fixture can be installed on the body of the fixture. Installation on the reflector is only needed when using Aluminum reflectors.
For fixtures without the reflector, install the j-box mounting plate as shown in steps 1 and 2 to the left.

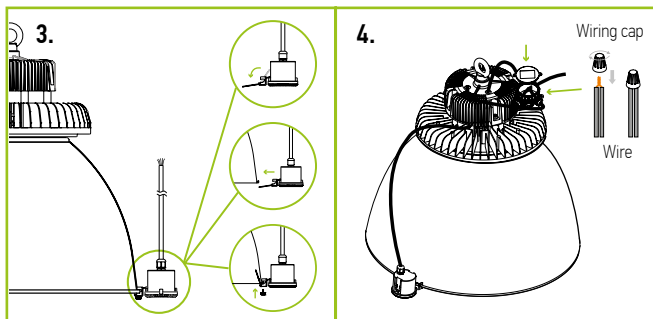

ELECTRICAL SCHEMATIC DIAGRAM:

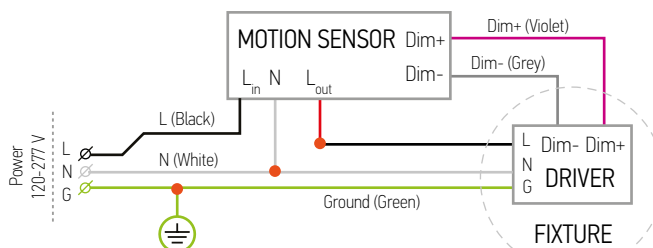

For most up-to-date spec sheets please refer to asd-lighting.com



LED UFO HIGH BAY

Standard and Premium Series

MOTION SENSOR UHB-MSK1 SETTINGS Please follow the additional motion sensor manual to setup your motion sensor.

USING DIP SWITCHES

Detection area, hold time, standby period, standby DIM level and daylight sensor can be set by using DIP switches on the sensor. Note that reducing the detection area will also reduce the sensitivity.

ON	1	
I	ON	100%
II	-	50%

Detection area

ON	2	3	4	
I	ON	ON	ON	5s
II	-	ON	ON	30s
III	ON	-	ON	1min
IV	-	-	ON	3min
V	ON	ON	-	20min
VI	-	-	-	30min

Hold time

Refers to the time period the lamp remains at 100% illumination after no motion detected.

ON	1	2	3	
I	ON	ON	ON	0 S
II	-	ON	ON	1 min
III	ON	-	ON	3 min
IV	-	-	ON	10 min
V	ON	ON	-	30 min
VI	-	-	-	+∞

ON	4	5	
I	ON	ON	10%
II	ON	-	20%
III	-	ON	30%
IV	-	-	50%

ON	6	7	8	9	
I	ON	ON	ON	ON	5 lux
II	-	ON	ON	ON	15 lux
III	ON	-	ON	ON	30 lux
IV	-	-	ON	ON	50 lux
V	ON	ON	-	ON	100 lux
VI	ON	ON	ON	-	150 lux
VII	-	-	-	-	Disable

Standby period

Refers to the time period the lamp remains at a pre-set dimming level before it completely switches off in the long absence of people. *When set to 0s, the lamp will work in an on/off function. *When daylight sensor is set to "Disable" and standby period to "+", the lamp will work using 2-step dimming control.

Standby dimming level

This is the pre-set dimming level you would like to have after the hold time in the long absence of people.





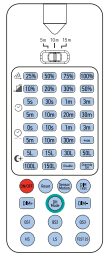

Daylight sensor

The sensor can be set to only allow the lamp to illuminate below a defined ambient brightness threshold. The settings are as follows: *When set to Disable Mode, the sensor will switch on the lamp when motion is detected regardless of ambient light levels.



USING REMOTE CONTROL

UHB-RC-MSK1 sold separately

Button	Remarks																								
ON / OFF	Press the "ON/OFF" button: the light goes to constant on/off mode and the sensor is disabled. Press "Reset" or "Auto mode" to quit this mode and the sensor starts to work.																								
Reset	Press "Reset" button: all parameters are the same as the DIP switch or factory settings.																								
Sensor motion	Press "Sensor motion" button, the light quits from the constant on/off mode and the sensor starts to work (The latest setting stays in validity).																								
Dim Test	Press "DIM Test" button: the 1-10 V dimming works to test whether the 1-10Vdc dimming ports are connected properly. After 2s, it returns to the latest setting automatically.																								
Override DH	Long press 3s: daylight priority mode will be switched to daylight threshold mode with the preset daylight value.																								
DIM+ DIM-	Set occupancy light level in range of 50%-100%. Dim level changes by 2% each time Dim+/Dim- is pressed.																								
DH Mode	Long press 3s: sensor will be switched to daylight priority mode, if the preset daylight value is set to «Disable» the sensor will stay in daylight threshold mode.																								
Scene Options	<table border="1"> <thead> <tr> <th>Detection Area</th> <th>Hold-Time</th> <th>Standby period</th> <th>Standby dim level</th> <th>Daylight Sensor</th> <th>Induction model</th> </tr> </thead> <tbody> <tr> <td>QS1</td> <td>100%</td> <td>5 min</td> <td>10 min</td> <td>10%</td> <td>30 Lux HS</td> </tr> <tr> <td>QS2</td> <td>100%</td> <td>10 min</td> <td>30 min</td> <td>10%</td> <td>Disable HS</td> </tr> <tr> <td>QS3</td> <td>100%</td> <td>20 min</td> <td>30 min</td> <td>10%</td> <td>Disable HS</td> </tr> </tbody> </table> <p>Note: Detection area / Hold-time / Standby period / Standby dim level / Daylight sensor can be adjusted by pressing the corresponding button. The latest setting will stay valid</p>	Detection Area	Hold-Time	Standby period	Standby dim level	Daylight Sensor	Induction model	QS1	100%	5 min	10 min	10%	30 Lux HS	QS2	100%	10 min	30 min	10%	Disable HS	QS3	100%	20 min	30 min	10%	Disable HS
Detection Area	Hold-Time	Standby period	Standby dim level	Daylight Sensor	Induction model																				
QS1	100%	5 min	10 min	10%	30 Lux HS																				
QS2	100%	10 min	30 min	10%	Disable HS																				
QS3	100%	20 min	30 min	10%	Disable HS																				
TEST 2S	Press the "TEST 2S" button at any time to enter test mode. In this mode the sensor parameters are as follows: Detection Area is 100%, Hold-Time is 5s, Standby Dim Level is 10%, Standby Period is 0s, daylight sensor is disabled. This function is only for testing. Press «Reset» or any other function button to exit this mode.																								
HS LS	Press the "HS" button for high sensitivity in the detection area. Press the "LS" button for low sensitivity in the detection area. The adjustment is based on the "Detection Area" parameter you set.																								
 Daylight Sensor	Set up daylight threshold: 5Lux/15Lux/30Lux/50Lux/100Lux/150Lux/ Disable																								
 Standby period	Set up standby time: 0S/10S/1min/3min/5min/10min/30min/+∞																								
 Hold-time	Set up hold-time: 5S/30S/1min/3min/5min/10min/20min/30min																								
 Standby dim level	Set up standby dim level: 10%/20%/30%/50%																								
 Detection Area	Set up detection area: 25%/50%/75%/100%																								
 Remote Distance	Toggle the button to set the remote distance of remote control and sensor.																								

Remote control and code setting conversion







- DIP switch settings convert to remote control: Press any button except "RESET" on the remote control, and the sensor settings convert to the function currently selected by the remote control. (No function button settings invalid)
- Remote control convert to DIP switch settings:
 - Press the "RESET" button on the remote control, and all settings return to the DIP switch settings of the sensor.
 - Turn off the power, toggle any DIP switch, connect to the power, and all settings return to the DIP switch settings when power is supplied again.

MOTION SENSOR UHB-MSK2 SETTINGS Please follow the additional motion sensor manual to setup your motion sensor.

USING REMOTE CONTROL ASD-CELP02H-MS sold separately



Remote control waive is 10 ft, every fixture needs to be set up separately

Button	Remarks																									
ON / OFF	Press the "ON/OFF" button: the light stays permanently on or off. *Press "Auto Mode", "RESET" or "Scene mode" buttons to quit this mode.																									
Auto Mode	Press "Auto Mode" button: the sensor starts to work and all settings remain the same as before the light was switched on/off.																									
Reset	Press "RESET" button: products with DIP switch will be controlled by DIP switches																									
Scene mode	<table border="1"> <thead> <tr> <th>Detection area</th> <th>Hold-time</th> <th>Daylight threshold</th> <th>Standby period</th> <th>Standby dimming level</th> </tr> </thead> <tbody> <tr> <td>SC1</td> <td>100%</td> <td>30s</td> <td>0.2Fc</td> <td>1min 10%</td> </tr> <tr> <td>SC2</td> <td>100%</td> <td>5min</td> <td>1Fc</td> <td>10min 10%</td> </tr> <tr> <td>SC3</td> <td>100%</td> <td>10min</td> <td>5Fc</td> <td>30min 10%</td> </tr> <tr> <td>SC4</td> <td>100%</td> <td>30min</td> <td>Disable</td> <td>+∞ 10%</td> </tr> </tbody> </table>	Detection area	Hold-time	Daylight threshold	Standby period	Standby dimming level	SC1	100%	30s	0.2Fc	1min 10%	SC2	100%	5min	1Fc	10min 10%	SC3	100%	10min	5Fc	30min 10%	SC4	100%	30min	Disable	+∞ 10%
Detection area	Hold-time	Daylight threshold	Standby period	Standby dimming level																						
SC1	100%	30s	0.2Fc	1min 10%																						
SC2	100%	5min	1Fc	10min 10%																						
SC3	100%	10min	5Fc	30min 10%																						
SC4	100%	30min	Disable	+∞ 10%																						
Test (2S)	The button "Test (2s)" is for testing purposes only. After pressing this button, the sensor goes to test mode (hold time is only 2s) automatically, standby period and daylight sensor are disabled. This mode can be ended by pressing "Reset", "Auto mode", "Scene mode" or "Hold-time". The sensor settings are changed accordingly. Brightness settings: Disable Test mode (can press any key to exit this mode).																									
 On/off control	There are 4 fixed scene mode programs built into the remote control to choose for different applications.																									
 Detection area	Press the button "detection range" to set detection range as 100% / 75% / 50% / 10%.																									
 Hold-time	Press the button "hold-time" to set hold-time as 5s / 30s / 1min / 3min / 5min / 10min / 20min / 30min.																									
 Daylight threshold	Press the button "daylight sensor" to set daylight threshold as 0.2Fc / 1Fc / 3Fc / 5Fc / 8Fc / 11Fc / disable.																									
 Standby period	Press the button "standby period" to set standby period as 0s / 10s / 30s / 1min / 5min / 10min / 30min / +∞. Note: "0s" means on/off control; "+∞" means bi-level dimming control.																									
 Standby dimming	Press the button "standby dimming level" to set the standby dimming level as 10% / 20% / 30% / 50%.																									

For most up-to-date spec sheets please refer to asd-lighting.com



LED UFO HIGH BAY

Standard and Premium Series

EMERGENCY BACK-UP POWER SUPPLY INFORMATION

WP-EWG-040U sold separately

EWG 40W, listed for field and factory installation, provides constant power output to the load during emergency mode operation. They maintain illumination in emergency mode for a minimum of 90 minutes. It is an ideal emergency solution for UFO LED highbay lights.

- ▶ Universal input range
- ▶ Integrated junction box design
- ▶ Field and factory installation
- ▶ IP65 for dry, damp and wet location
- ▶ 40W & 90mins durable emergency operating time
- ▶ Surge L-N: 3KV; L&N-PE: 3KV
- ▶ Protection: Over-Voltage, Short-Circuit, Over-Load, Open-Circuit
- ▶ LiFePO4 safety batteries
- ▶ Link to the input of LED drivers
- ▶ Remote test via handheld controller
- ▶ Self-diagnostic every month and year
- ▶ 5-year warranty from manufacture date
- ▶ Remote controller (sold separately)

Specifications	
Input Voltage	120-277 V
Input Current	0.2A Max.
Input Power	12W Max.
Standby Input Power	< 0.8 W (Finished charging)
Maximum standby time between Recharges	12 Months
Driver Type	Constant power
Output Power (Emergency Mode)	40 W
Output Voltage Range	120-200 Vdc
Maximum Load Power	300 W (When dimming to a minimum, the power needs to be less than 36W)
Peak Output Power (Emergency Mode)	100 W (last time 10 seconds)
Number of Output Channels	1 Channel
RFI/EMI	FCC Part 15 Class B
Output Type	LED Class 1
Battery Type	LiFePO4 16Vdc
Battery Capacity Available	6000 mAh (96 WH)
Battery Recharge Time	24 Hours
Battery Discharge Time	90 Min.
Maximum lighting fixture weight	44.1 lbs (20 Kg)
Self-Diagnostic Test System	In the normal charging mode, the system performs a self-diagnostic test every 30 days, the system switches to emergency mode for 30S, and then automatically switches back to the normal charging mode.
	In the normal charging mode, the system switches to emergency mode every 360 days (after 11 Monthly self-diagnostic test) and works until the end of discharge. Automatically switches back to normal charging mode after discharge.
Ambient Operating Temperature Range	50°F to 122°F (10°C to 50°C)
Service Life	50,000 hours
Maximum mounting height	36 FT (11 m)
Input Surge Protection	2.5 KV Ring Wave, L-N & L/N-PE 3 KV
Protections	Battery Over Discharge Protection
	Output Short Circuit Protection
Approvals/Class	RoHS, UL924 Listed, CEC Title 20
	Dry, Damp and Wet Locations



For more information please see the Cut sheet from the package.

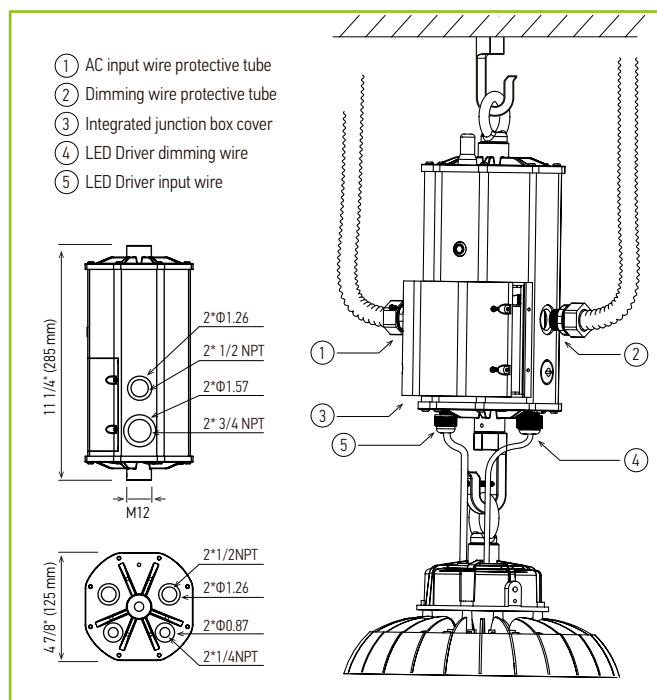

ELECTRICAL SCHEMATIC DIAGRAM:

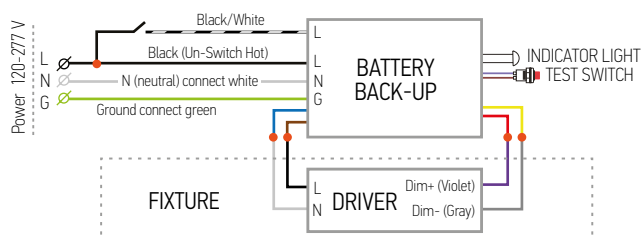

For most up-to-date spec sheets please refer to asd-lighting.com

ASD LIGHTING CORP

E-mail: orders@asd-lighting.com | Web site: www.asd-lighting.com





LED UFO HIGH BAY

Standard and Premium Series

ORDERING INFORMATION

LED UFO HIGH BAY FIXTURE:

Model	Watts	CCT	Pcs. per Carton	Carton Size	Carton Weight	UPC
ASD-UHB2-100D35-STD	100 W	3,500 K	1	12.2" x 12.2" x 6.9"	7.7 lb	819201025664
ASD-UHB2-150D35-STD	150 W	3,500 K	1	12.2" x 12.2" x 6.9"	7.7 lb	819201025671
ASD-UHB2-200D35-STD	200 W	3,500 K	1	12.2" x 12.2" x 7.7"	8.6 lb	819201025688
ASD-UHB2-100D40W-PRM	100 W	4,000 K	1	12.2" x 12.2" x 6.9"	7.7 lb	810050733281
ASD-UHB2-100D50-PRM	100 W	5,000 K	1	12.2" x 12.2" x 6.9"	7.7 lb	819201023486
ASD-UHB2-100D50W-PRM	100 W	5,000 K	1	12.2" x 12.2" x 6.9"	7.7 lb	810050733298
ASD-UHB2-150D40W-PRM	150 W	4,000 K	1	12.2" x 12.2" x 6.9"	7.7 lb	810050733304
ASD-UHB2-150D50-PRM	150 W	5,000 K	1	12.2" x 12.2" x 6.9"	7.7 lb	819201023493
ASD-UHB2-150D50W-PRM	150 W	5,000 K	1	12.2" x 12.2" x 6.9"	7.7 lb	810050733311
ASD-UHB2-200D40W-PRM	200 W	4,000 K	1	12.2" x 12.2" x 7.7"	8.6 lb	810050733328
ASD-UHB2-200D50-PRM	200 W	5,000 K	1	12.2" x 12.2" x 7.7"	8.6 lb	819201023509
ASD-UHB2-200D50W-PRM	200 W	5,000 K	1	12.2" x 12.2" x 7.7"	8.6 lb	810050733335
ASD-UHB2-240D50-PRM	240 W	5,000 K	1	15.2" x 15.2" x 7.9"	10 lb	819201024018
ASD-UHB2-300D50-PRM	300 W	5,000 K	1	15.2" x 15.2" x 7.9"	17.2 lb	819201025855
ASD-UHB2HV-100D50-PRM	100 W	5,000 K	1	12.2" x 12.2" x 6.9"	7.7 lb	819201023516
ASD-UHB2HV-150D50-PRM	150 W	5,000 K	1	12.2" x 12.2" x 6.9"	8.4 lb	819201023523
ASD-UHB2HV-200D50-PRM	200 W	5,000 K	1	12.2" x 12.2" x 7.7"	9.7 lb	819201023530
ASD-UHB2HV-240D50-PRM	240 W	5,000 K	1	15.2" x 15.2" x 7.9"	10 lb	819201026029

ACCESSORIES:

Model	Name	Weight	Dimensions		
ASD-H-M10	Spring Hook for LED UFO High Bays UHB 100-200W M10	0.3 lb	3 15/16" x 2 1/2" x 3/8"		
ASD-H-M12	Spring Hook for LED UFO High Bays UHB 240-300W M12	0.3 lb	4 1/8" x 2 1/2" x 1/2"		
ASD-HS-M10	Screw-bolt hook for LED UFO High Bay UHB 100-200W M10	0.2 lb	1 1/4" x 1 1/16" x 3 1/8"		
ASD-SMB100/300-UHB2	Surface mount Bracket for 100/300W LED UFO High Bays UHB2	1 lb	9 11/16" x 3 1/8" x 5 5/16"		
ASD-PMB-UHB	Pendant Mount Bracket LED UFO High Bays	0.6 lb	2 3/8" x 1 1/2" x 2 7/8"		
ASD-DUHB-16-90AL	Aluminum Reflector 16" 90° for LED UFO High Bays UHB	1.4 lb	15 3/4" x 5 1/8"		
ASD-DUHB-21-120ALG	Aluminum Reflector 21" 120° for LED UFO High Bays UHB	1.1 lb	21" x 4 1/8"		
ASD-DUHB-16-90PC	Polycarbonate Reflector 16" 90° for LED UFO High Bays UHB	1.4 lb	16 1/4" x 3 7/8"		
ASD-DUHB-19-90PC	Polycarbonate Reflector 19" 90° for LED UFO High Bays UHB	1.3 lb	18 7/8" x 5 1/2"		
ASD-BLUHB-16PC	Polycarbonate Bottom Conical Lens for 16" Reflector DUHB	1.1 lb	16" x 1 1/4"		
ASD-BLUHB-19PC	Polycarbonate Bottom Conical Lens for 19" Reflector DUHB	1.4 lb	18 3/4" x 1 5/8"		
UHB-MSK1	Microwave motion sensor kit for LED UFO High Bays UHB	1 lb	3 1/8" x 2 1/2"		
UHB-RC-MSK1	Remote Control	0.1 lb	4 1/2" x 2 1/8" x 1/2"		
UHBHV-MSK2	Microwave motion sensor kit High Voltage for LED UFO High Bays UHB	1.1 lb	3 1/8" x 2 1/2"		
ASD-CELP02H-MS	Remote Control	0.1 lb	2" x 1" x 1/2"		
WP-EWG-040U	LED Emergency back-up power supply 40W dimming 0-10V for UFO 100-300W	8.2 lb	4 7/8" x 4 7/8" x 11 1/4"		
EMK-RC	Remote test switch for LED Emergency back-up power supply	0.2 lb	5 3/4" x 1 8" x 1 8"		
LLT-M19CS03	Inline Wire Connector	0.1 lb	7 5/8" x 2 1 8"		
ASD-CRD6-TLP-277V	6-foot Cord 120V-277V 3-Blade Twist-Lock Plug	0.6 lb	70 7/8" x 3/8"		
ASD-CRD6-SBP-277V	6-foot Cord 120V-277V Straight Blade Plug	0.7 lb	70 7/8" x 3/8"		
Model	Pcs. per Carton	Carton Size	Carton Weight	UPC	GTIN 14
ASD-H-M10	50	12.2" x 12.2" x 6.9"	16.5 lb	819201025312	20819201025316
ASD-H-M12	50	12.2" x 12.2" x 6.9"	16.5 lb	810050730556	10810050730553
ASD-HS-M10	50	12.2" x 12.2" x 6.9"	10.1 lb	810050731164	10810050731161
ASD-SMB100/300-UHB2	20	20.3" x 16.9" x 11.8"	23.1 lb	819201026999	10819201026996
ASD-PMB-UHB	100	15.4" x 15.4" x 9.4"	59.1 lb	810050731522	10810050731529
ASD-DUHB-16-90AL	20	16.5" x 16.5" x 14.6"	16.8 lb	819201020621	10819201020628
ASD-DUHB-21-120ALG	10	22" x 22" x 7.5"	14.6 lb	819201020638	10819201020635
ASD-DUHB-16-90PC	10	16.9" x 16.9" x 7.9"	16.8 lb	819201020607	10819201020604
ASD-DUHB-19-90PC	10	19.7" x 19.7" x 9.1"	16.1 lb	819201020614	10819201020611
ASD-BLUHB-16PC	10	16.9" x 16.9" x 5.1"	11.7 lb	819201020645	10819201020642
ASD-BLUHB-19PC	10	19.7" x 19.7" x 5.1"	16.1 lb	819201020659	10819201020659
UHB-MSK1	40	20.7" x 12.4" x 19"	49.0 lb	819201021994	10819201021991
UHB-RC-MSK1	100	9.8" x 6.9" x 12"	11.3 lb	819201022007	10819201022004
UHBHV-MSK2	32	21.9" x 14.8" x 12.6"	40.2 lb	819201025848	20819201025848
ASD-CELP02H-MS	50	11.4" x 6.5" x 5.3"	6.6 lb	819201023479	10819201023476
WP-EWG-040U	2	14.6" x 7.5" x 13.4"	18.1 lb	810050731171	10810050731178
EMK-RC	10	12.2" x 12.2" x 6.9"	3.5 lb	810050731188	10810050731185
LLT-M19CS03	1000	17.7" x 11" x 10.2"	55.1 lb	819201020591	10819201020598
ASD-CRD6-TLP-277V	25	10.8" x 9.8" x 11.6"	15.9 lb	819201026296	10819201026293
ASD-CRD6-SBP-277V	25	10.8" x 9.8" x 11.6"	17.6 lb	819201026302	10819201026309

For most up-to-date spec sheets please refer to asd-lighting.com

