



# LED STAIRWELL FIXTURE

## WITH MOTION SENSOR

► **DESIGN & OPTIONS** - LED STAIRWELL FIXTURE WITH MOTION SENSOR has a narrow, low-profile design with a smooth PMMA lens for even illumination with no glare and durable body with knock outs on both ends. The built-in bi-level microwave motion sensor turns off the fixture automatically when no motion is detected. This fixture, with 120-277V and a 0-10V dimmable driver, also includes power and color changing options, letting you set it to 3500K, 4000K or 5000K with a simple switch. Models with battery back-up are also available. The built-in battery back-up ensures 90 minutes of power.

► **INSTALLATION** - Installation is easy: all you have to do is snap together the housing and the lens. Side and end entry points on the fixture make it easy to connect multiple fixtures to one switch using our connection bracket (sold separately). It can be surface or suspended mounted. Refer to install instructions for detailed steps.

► **APPLICATION** - The LED STAIRWELL FIXTURE WITH MOTION SENSOR is perfect commercial or industrial solution locations such as: offices, conference rooms, schools, hospitals, hallways, stairwells, basements, workshops, laundry rooms, garages, and storage areas just to name a few. The fixture is Dimm location rated and can operate in temperatures between -4+104°F (-20+40°C), allowing it to be utilized in a wide variety of applications and climates.

► **ENERGY SAVINGS & EFFICIENCY** - This fixture provides a lumen output equal to or higher than traditional fluorescent vapor lights and can cut your electric bill by up to 80% instantly. With a lifespan of 54,000 hours, these fixtures are made to last decades under normal operation! This fixture will save you a significant amount of money in its lifetime.

► **CERTIFICATION & WARRANTY** - Buy with confidence: ASD provides a 5-year warranty along with UL and DLC Premium Stairwell and Passageway Luminaires certifications to guarantee top quality products and safety!

Top US certifications allow participation in rebates; please check the rebate programs available in your state.

Catalog number	
Notes	
Type	

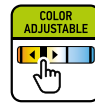

OPTION

### PRODUCT LEGEND:

Family	Series	Size	Dimmable	Watts	CCT	Options	Series
ASD-LSF	5	X	X	XX	XX	XX	XX
LED Stairwell fixture		4 = 4 ft	A = Power Adjustable	44 = 22/28/36/44 W	AC = 3,500/4,000/5,000 K	EM = Battery back-up MS = Motion Sensor	SW = Stairwell

### LED STAIRWELL FIXTURE:

Model	Type	Watts	Voltage	Dimmable	Lumens	CCT	Dimensions (LxWxH)	DLC
ASD-LSF5-4A44AC-MS-SW	4 ft	22/28/36/44 W	120-277 V	0-10 V	3,161/3,879/4,953/5,724 lm	3,500/4,000/5,000 K	46 7/8" x 2 1/2" x 2 11/16"	Stairwell
ASD-LSF5-4A44AC-EM-MS-SW	4 ft	22/28/36/44 W	120-277 V	0-10 V	3,161/3,879/4,953/5,724 lm	3,500/4,000/5,000 K	46 7/8" x 2 1/2" x 2 11/16"	Stairwell

### ORDERING INFORMATION:

Model	UPC	GTIN 14	Pcs per Carton	Carton Size	Carton Weight
ASD-LSF5-4A44AC-MS-SW	810050730266	10810050730263	8	48.3" x 12.5" x 6.7"	40.1 lbs
ASD-LSF5-4A44AC-EM-MS-SW	810050733540	10810050733547	8	48.3" x 12.5" x 6.7"	47.5 lbs

### ACCESSORIES:

Model	Name	Materials	Weight	Dimensions	
ASD-CB-LSF5	Connection bracket for LSF5	Metal	0.2 lbs (0.1 kg)	5 1/4" x 2 3/4" x 5/8"	
ASD-RC-RC100	Remote Control	Plastic	0.2 lbs (0.1 kg)	4 7/8" x 2 3/4" x 3/4"	
Model	UPC	Pcs per Carton	Carton Size	Carton Weight	GTIN 14
ASD-CB-LSF5	810050730747	100	14.3" x 5.7" x 8.1"	20.9 lbs	10810050730744
ASD-RC-RC100	819201023585	50	9.8" x 15.7" x 9.4"	14.3 lbs	10819201023582

For most up-to-date spec sheets please refer to [asd-lighting.com](http://asd-lighting.com)



# LED STAIRWELL FIXTURE

## WITH MOTION SENSOR

### PRODUCT SPECIFICATIONS:

Construction & Materials			Electrical System	
Lens	Translucent white lens		Input Voltage	120-277V AC
Housing	Iron		Max input current	0.41 A
Finish Color	White		Inrush current (Action time)	50 A (<1S)
Weight	ASD-LSF5-4A44AC-MS-SW	4.1 lb (1.9 kg)	AC input range	min 120 V max 277 V
	ASD-LSF5-4A44AC-EM-MS-SW	5.1 lb (2.3 kg)	Off State Power	0 W
Environmental System			Power Consumption	22/28/36/44 W
Work Environment	Suitable for Damp Locations, IP20		Power Factor	≥ 0.9
Operating Temperature	-4°F to 104°F (-20°C to 40°C)		Output voltage	42 V
L70 life	R > 54,000 hrs, C > 174,000 hrs		Max output current	500 mA/600 mA/800 mA/1 A
Optical System			Surge protection	2kV
Luminous Flux	3,161/3,879/4,953/5,724 lm		LED driver class	Class 2
Color Temperature	3,500/4,000/5,000 K			
CRI	80			
Dimming compatible controls				
Brand	Model Number			
Leviton	DS710	IP710		
Lutron	NTSTV-DV	NFTV	DVTV-WH	
Legrand	H4FBL3PW			
Regular and Voluntary Certifications				
5-year limited warranty				
DesignLights Consortium (DLC) listed (Classification: Premium series)				
Main: Outdoor Luminaires				
General Application: Mid Output				
Primary Use: Stairwell and Passageway Luminaires				
Certification cULus listed				

### PACKAGE CONTENTS:

Description	Q-ty
LED Stairwell Fixture	1
V Hook	2
J-box mounting plate	2
Box	1
Cut Sheet	2

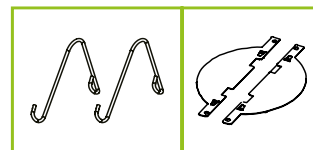

### OPTIONAL ACCESSORIES:

Connection bracket for LSF5  
ASD-CB-LSF5

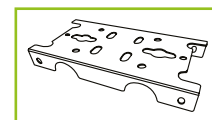

## INSTALLATION GUIDE

### IMPORTANT SAFETY INFORMATION:

Please read all the instructions below before installation.

- ▶ Make sure that the supply voltage corresponds to the rated product voltage.
- ▶ The product must be installed by a qualified electrician in accordance with the National Electrical Code and corresponding local codes.
- ▶ If the product is damaged, do not use it.

### ⚠ WARNING

**RISK OF PERSONAL INJURY** – READ and follow all WARNINGS and installation instructions.

Keep or give to the owner for future reference.

**Risk of cuts:** Wear gloves to prevent cuts or abrasions when removing from carton, handling, installing, and maintaining this product.

**Risk of electric shock:** This product must be installed in accordance with the applicable installation code by a person familiar with the construction and operation of the product and the hazards involved.

**Risk of Fire:** Minimum 194°F supply conductors. Consult a qualified electrician to ensure correct branch circuit conductor.

ASD® assumes no responsibility for claims arising out of improper or careless Installation or handling of this product.

### ELECTRICAL SCHEMATIC DIAGRAM:

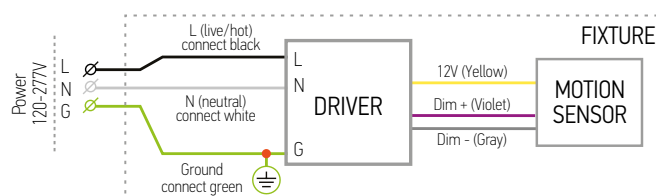

### ELECTRICAL SCHEMATIC DIAGRAM BATTERY BACK-UP:

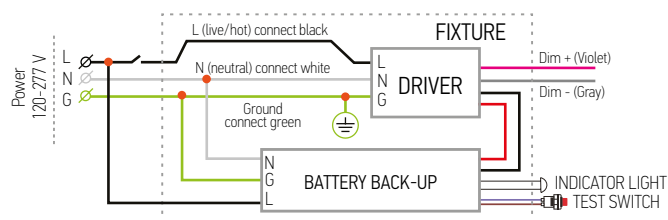

For most up-to-date spec sheets please refer to [asd-lighting.com](http://asd-lighting.com)



# LED STAIRWELL FIXTURE

WITH MOTION SENSOR

## MICROWAVE MOTION SENSOR INFORMATION:

Specifications	
Power supply	12-24 V DC
HF system	5.8 GHz ± 75 MHz
Dim control output	0-10V, max. 25 mA sinking current
Detection radius/angle	Max 26ft (8 m) / 360°
Mounting height	Max 20 ft
Remote range	50 ft (15 m) indoor, no backlight
Humidity	Max 95% RH
Temperature	-40°F - 158°F (-40°C - 70°C)

**⚠**  
RF interference  
may affect the operation  
of this sensor

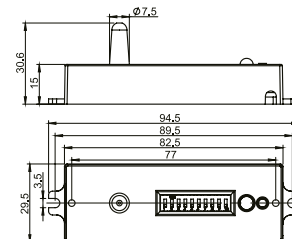

## MOTION SENSOR SETTINGS:

Please follow the additional motion sensor manual to set up your motion sensor.



## DEFAULT SETTING:

Detection Area	Hold Time	Daylight Sensor	Stand-by Period	Stand-by Dim Level
100 %	5 min	Disable	0 S	10 %

## USING DIP SWITCHES:

Detection area, hold time, stand-by period, stand-by DIM level and daylight sensor can be set by using DIP switches on the sensor. Note that reducing the detection area will also reduce the sensitivity.

ON	1	2	
I	-	-	20%
II	-	ON	50%
III	ON	-	75%
IV	ON	ON	100%

ON	3	4	
I	-	-	10s
II	-	ON	1min
III	ON	-	5min
IV	ON	ON	15min

ON	5	6	
I	-	-	-
II	-	ON	10 Lux
III	ON	-	30 Lux
IV	ON	ON	50 Lux

ON	7	8	
I	-	-	0%
II	-	ON	10%
III	ON	-	30%
IV	ON	ON	50%

ON	9	10	
I	-	-	+∞
II	-	ON	1 min
III	ON	-	30 min
IV	ON	ON	60 min

### Detection Range

Detection range is the term used to describe the radii of the detection zone produced on the ground after mounting the sensor light at a height of 8-20ft.

### Hold time

The light can be set to stay ON for any period of time between approx. 10sec and a maximum of 15min. Any movement detected before this time elapses will restart the timer. It is recommended to select the shortest time for adjusting the detection zone and for performing the walk test.

### Light-control

The chosen light response threshold can be infinitely from approx.











### Stand-by dimming level

This is the preset dimming level you would like to have after the hold time in the long absence of people.

### Stand-by period

Refers to the time period the lamp remains at a preset dimming level before it completely switches off in the long absence of people.

## LED INDICATORS:

BUTTON	DESCRIPTION	BUTTON	DESCRIPTION
	Press the "ON/OFF" button: the light goes to constant on/off mode, and the sensor is disabled. (MUST press "Auto" button to quit this mode.		Press "Auto" button: the sensor starts to function and all settings remain the same as the latest status before the light is switched on/off.
	Display the current/latest setting parameters in LED indicators (the LED indicators will turn on, showing the setting parameters).		The button "TEST" is for testing sensitivity only. After you choose sensitivity thresholds, press the "TEST" button. The sensor goes to test mode (hold time is only 2s) automatically, meanwhile the stand-by period and daylight sensor are disabled. Press "AUTO" button to quit this mode.
	Press "RESET" button: all settings go back to settings of dip switch in sensor.		
	Enter in the setting condition, and press up or down to select parameters in LED indicators.		Press this button to turn the smart photocell sensor on/off, which takes the place of a normal photocell sensor switch. When the remote control enters in setting conduction, you can choose to turn the smart photocell sensor on/off. If the smart photocell sensor mode is on, two led indicators of DAYLIGHT SENSOR are on, so the set point of the photocell sensor turning the light on/off can be set. Stand by time is set to infinite by default. When the natural light level exceeds the set point of the light, the sensor will wait and monitor for 1 minute in order to confirm the natural light level increase is not temporary before forcing the lights to turn off (even if the space is occupied). When the natural light level is lower than the set point of the light, the sensor will wait and monitor for 1 minute in order to confirm the natural light level decrease is not temporary before forcing the lights to turn on (even when the space is not occupied).
	Navigate to LEFT and RIGHT to select parameters in LED indicators.		
	Keep records of selected parameters in remote control or in mode 1, mode 2, mode 3, or mode 4.		
	Upload the selected parameters to sensors.		
	4 scene modes with preset parameters which can be changed and saved in modes.		

## REMOTE CONTROL (ASD-RC-RC100 SOLD SEPARATELY)

Specifications	
Power supply	2 X AAA 1.5V BATTERY, ALKALINE PREFERRED
Communication	940 nm Infrared Tx & Rx
Upload range	Up to 50 ft. (15 m)
Op. temperature	32°F-122°F (0°C-50°C)
Dimensions	4.84" x 2.76" x 0.8" (123 x 70 x 20.3 mm)

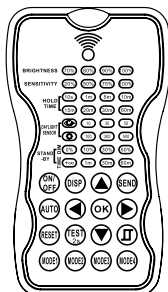

For most up-to-date spec sheets please refer to [asd-lighting.com](http://asd-lighting.com)



# LED STAIRWELL FIXTURE

WITH MOTION SENSOR

## BATTERY BACK-UP DETAILS:

- ▶ Standard CSA C22.2 NO.141, UL924
- ▶ Battery Back-up Lithium Battery
- ▶ Battery Protection: over-charge, over-discharge and short circuit protection
- ▶ The wall switch only controls the main power, it does not affect emergency function.
- ▶ Indicator light modes: Red light ON – the emergency driver is charging in standby mode; Red light OFF – AC power is out, the emergency driver works in emergency mode.
- ▶ Press Test button and release to cut the power to the AC driver and switch the system to emergency mode. The Red light will turn off, and the fixture will decrease in light amount. The system will come back to normal AC mode after about 3 seconds.
- ▶ Batteries Meet 500 cycles of standard CH and standard DCH.
- ▶ RoHS compliant

### AC Operation:

When AC power is present, the LED load from the LED driver is the normal power supply, AC LED driver output current cannot exceed 150W or 4A. The emergency driver will be charging in standby mode as indicated by the green LED light.

### Emergency operation:

When the AC power goes out, the emergency driver detects the AC power outage and automatically switches to the working emergency mode. The green LED light will be off. When the AC power is restored, the emergency driver switches back to AC power and starts re-charging. The green LED light will then turn back on.

### ⚠ WARNING

This product should be installed by a qualified electrician. Connecting wires when power is on is not allowed. Power can be turned on after making sure that there is no phenomenon of short circuit and the connection is ok.

## BATTERY BACK-UP INFORMATION:

Battery capacity	Max emergency output power	Battery back up current	Battery back up operation time	Battery voltage	Full charge/discharge cycles
3,000 mAh	8 W	250 mA	≥ 90 minutes	6.4 V	500 cycles
3,000 mAh	15 W	250 mA	≥ 90 minutes	9.6 V	500 cycles

## CHANGING COLOR TEMPERATURE:

Change the position of the CT switch on the housing according to the required CT mode.

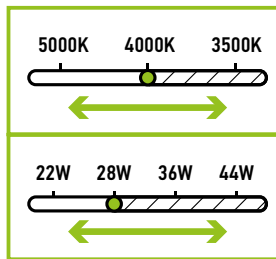

## CHANGING POWER MODE:

During installation, select the required preset wattage. Do not remove the knock-out cover panel that limits the access of authorized personnel.

## INSTALLATION STEPS:

### CHAIN AND V HOOK MOUNTING:

1. Insert chain on each hook and insert the hook into the installation holes. Attach the chain to the ceiling and adjust until balanced and secure.
2. Connect wires from fixture to power supply. Contain wires in metal or plastic wire hose. If need to connect one fixture to another please use connection bracket (sold separate).

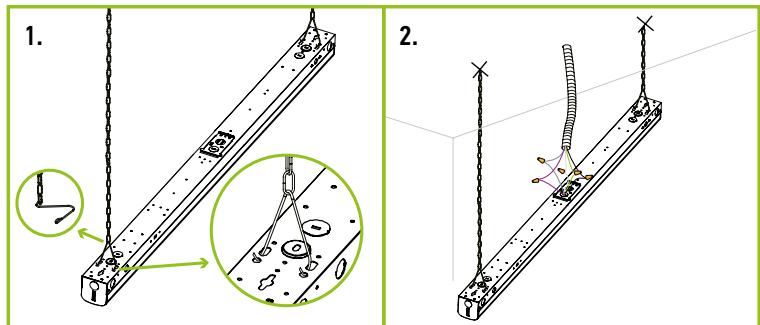

### SURFACE MOUNTING:

1. Lock the J-box mounting plate and open the LED module and pass the AC wires through the hole on the back side of fixture.
2. Then source the lamp housing to the ceiling and connect the AC wires and dimming wires (if used). After wiring lift the LED module back to the housing. Finish installation and test the light.

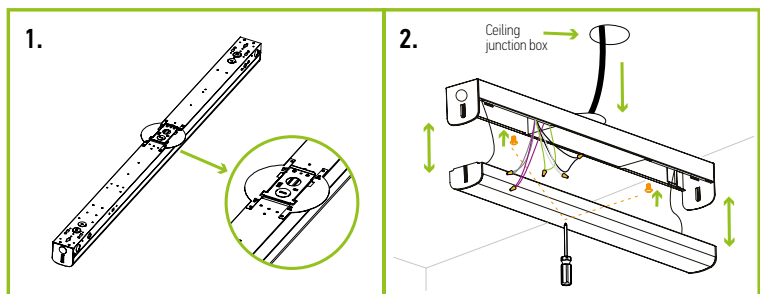

For most up-to-date spec sheets please refer to [asd-lighting.com](http://asd-lighting.com)



# LED STAIRWELL FIXTURE

## WITH MOTION SENSOR

### CONNECTING MULTIPLE FIXTURES:

1. Open LED module and remove knockout ring according to your needs on the end or side of the fixture. Feed the AC wires and dimming wires through the knockout hole and connect with fixture wires inside of the luminaire. If 0-10v dimming system is available, connect the purple and gray wires to the corresponding purple and gray wires in the built-in dimming system.

CAUTION: Customer supplied AC wire must be 18AWG. The maximum number of fixtures allowed to be linked together is indicated in the following table.

2. If need to source one fixture to another please use connection bracket (sold separately). Repeat the process for the next fixture.

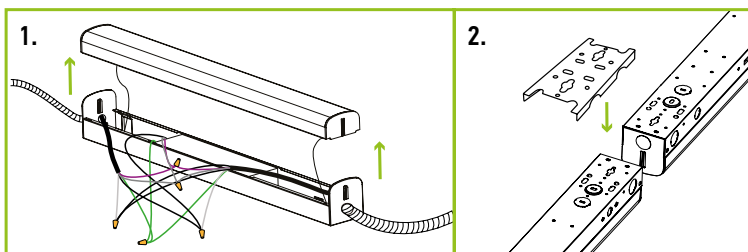

Model	Linkable Quantities Depending on Voltage			
	18 AWG		16 AWG	
	120V	277V	120V	277V
22 W	16	38	27	63
28 W	13	30	21	49
36 W	10	23	17	38
44 W	8	19	14	31

\*Recommended wire thickness should not exceed 18AWG.

### ELECTRICAL SCHEMATIC DIAGRAM CONNECTING MULTIPLE FIXTURES WITH MOTION SENSOR:

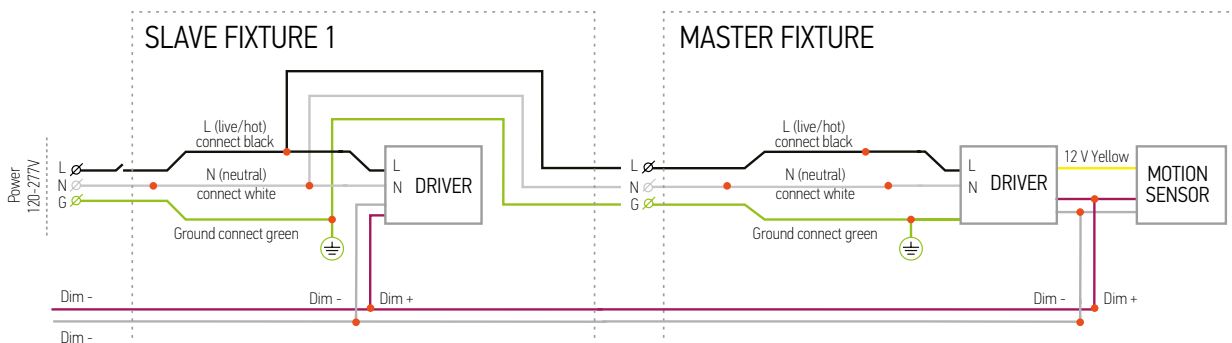

### ELECTRICAL SCHEMATIC DIAGRAM CONNECTING MULTIPLE FIXTURES WITH BATTERY BACK-UP:

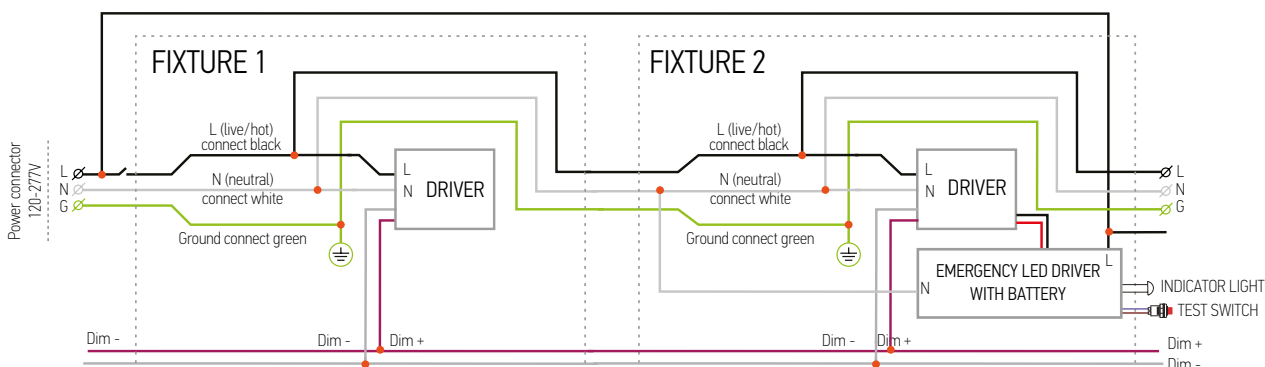

For most up-to-date spec sheets please refer to [asd-lighting.com](http://asd-lighting.com)