

ASD[®] LED UFO HIGH BAY

► **DESIGN** - LED UFO HIGH BAY is extremely efficient with a 150lm/W output. Die-cast aluminum housing with excellent heat dissipation along with an anti-glare PC lens provide many years of use. It can operate in temperatures ranging from -40 to 149°F. It is designed to operate on 120-277V or 277-480V circuits with a 0-10V dimmable driver.

► **MOTION SENSOR** - The built-in microwave motion sensor will turn off the fixture automatically when no motion is detected. The sensor can be adjusted using the handheld remote.

► **IP69K** - rating provides protection against ingress of dust and high temperature, high pressure water.

► **SURGE PROTECTION** - 6kV protects the fixture from voltage spikes and current surges.

► **INSTALLATION** - This fixture has three different mounting options: suspended, surface, and pendant. It comes with 4 ft cord. Perfect commercial or industrial solution for warehouses, supermarkets, retail stores, gyms, and many other applications.

► **ADVANTAGES** - With calculated lifespan up to 152,000 hours, these fixtures are made to last decades under normal operation! ASD provides a 5-year limited warranty along with UL and DLC Premium certifications to guarantee top quality products and safety!

Catalog number	
Notes	
Type	



Finish:	White
	Black

Model	Watts	Voltage	Dimmable	Lumens	CCT	Finish	Dimensions (LxWxH)	Cord	Option
UHB2									
ASD-UHB2-100D35-PRM	100W	120-277 V	1-10 V	14,600 lm	3,500 K	Black	10-1/4" x 10-1/4" x 6-1/4"	4 ft	-
ASD-UHB2-100D50W-PRM	100W	120-277 V	1-10 V	14,800 lm	5,000 K	White	10-1/4" x 10-1/4" x 6-1/4"	4 ft	-
ASD-UHB2-100D50-PRM	100W	120-277 V	1-10 V	14,800 lm	5,000 K	Black	10-1/4" x 10-1/4" x 6-1/4"	4 ft	-
ASD-UHB2-150D35-PRM	150W	120-277 V	1-10 V	21,900 lm	3,500 K	Black	10-1/4" x 10-1/4" x 6-7/8"	4 ft	-
ASD-UHB2-150D40W-PRM	150W	120-277 V	1-10 V	22,050 lm	4,000 K	White	10-1/4" x 10-1/4" x 6-7/8"	4 ft	-
ASD-UHB2-150D50W-PRM	150W	120-277 V	1-10 V	22,200 lm	5,000 K	White	10-1/4" x 10-1/4" x 6-7/8"	4 ft	-
ASD-UHB2-150D50-PRM	150W	120-277 V	1-10 V	22,200 lm	5,000 K	Black	10-1/4" x 10-1/4" x 6-7/8"	4 ft	-
ASD-UHB2-150A50-BK	100/120/150W	120-277 V	0-10 V	15,885/18,982/23,282 lm	5,000 K	Black	11" x 11" x 6-3/4"	4 ft	-
ASD-UHB2-200D35-PRM	200W	120-277 V	1-10 V	29,200 lm	3,500 K	Black	10-1/4" x 10-1/4" x 6-7/8"	4 ft	-
ASD-UHB2-200D40W-PRM	200W	120-277 V	1-10 V	29,400 lm	4,000 K	White	10-1/4" x 10-1/4" x 6-7/8"	4 ft	-
ASD-UHB2-200D50W-PRM	200W	120-277 V	1-10 V	29,600 lm	5,000 K	White	10-1/4" x 10-1/4" x 6-7/8"	4 ft	-
ASD-UHB2-200D50-PRM	200W	120-277 V	1-10 V	29,600 lm	5,000 K	Black	10-1/4" x 10-1/4" x 6-7/8"	4 ft	-
ASD-UHB2-200A50-BK	100/150/200W	120-277 V	0-10 V	15,885/24,520/30,978 lm	5,000 K	Black	11" x 11" x 6-3/4"	4 ft	-
ASD-UHB2-240D50W-PRM	240W	120-277 V	1-10 V	35,520 lm	5,000 K	White	12-9/16" x 12-9/16" x 6-3/4"	4 ft	-
ASD-UHB2-240D50-PRM	240W	120-277 V	1-10 V	35,520 lm	5,000 K	Black	12-9/16" x 12-9/16" x 6-3/4"	4 ft	-
ASD-UHB2-240A50-BK	150/200/240W	120-277 V	0-10 V	22,876/30,720/37,120 lm	5,000 K	Black	12-5/8" x 12-5/8" x 6-3/4"	4 ft	-
ASD-UHB2-300D50-PRM	300W	120-277 V	1-10 V	45,000 lm	5,000 K	Black	12-9/16" x 12-9/16" x 7-3/4"	4 ft	-
ASD-UHB2-400D50-PRM	400W	120-277 V	0-10 V	60,000 lm	5,000 K	Black	14-1/8" x 14-1/8" x 9-1/4"	4 ft	-
ASD-UHB2-500D50-PRM	500W	120-277 V	0-10 V	75,000 lm	5,000 K	Black	14-1/8" x 14-1/8" x 9-1/4"	4 ft	-
UHB2-HE									
ASD-UHB2-HE-240D50-BK	240W	120-277 V	0-10 V	39,594 lm	5,000 K	Black	10-1/4" x 10-1/4" x 7-9/16"	4 ft	-
ASD-UHB2-HE-500D50-BK	500W	120-277 V	0-10 V	82,740 lm	5,000 K	Black	14-3/4" x 14-3/4" x 11"	4 ft	-
ASD-UHB2-HE-600D50-BK	600W	120-277 V	0-10 V	98,935 lm	5,000 K	Black	14-3/4" x 14-3/4" x 15-5/16"	4 ft	-
UHB2HV HIGH VOLTAGE									
ASD-UHB2HV-150D50-PRM	150W	277-480 V	0-10 V	22,500 lm	5,000 K	Black	10-1/4" x 10-1/4" x 7-5/16"	4 ft	-
ASD-UHB2HV-200D50-PRM	200W	277-480 V	0-10 V	30,000 lm	5,000 K	Black	10-1/4" x 10-1/4" x 7-1/4"	4 ft	-
ASD-UHB2HV-300D50-PRM	300W	277-480 V	0-10 V	45,000 lm	5,000 K	Black	12-5/8" x 12-5/8" x 8-1/4"	4 ft	-
ASD-UHB2HV-400D50-PRM	400W	277-480 V	0-10 V	56,000 lm	5,000 K	Black	14-3/16" x 14-3/16" x 12-1/8"	4 ft	-
ASD-UHB2HV-500D50-PRM	500W	277-480 V	0-10 V	70,000 lm	5,000 K	Black	14-3/16" x 14-3/16" x 12-1/8"	4 ft	-
UHB2-MS WITH MOTION SENSOR									
ASD-UHB22-100D50-MS	100W	120-277V	1-10 V	14,800 lm	5,000 K	Black	10-1/4" x 10-1/4" x 7-1/2"	4 ft	Motion sensor
ASD-UHB22-150D50-MS	150W	120-277V	1-10 V	22,200 lm	5,000 K	Black	10-1/4" x 10-1/4" x 7-1/2"	4 ft	Motion sensor
ASD-UHB22-200D50-MS	200W	120-277V	1-10 V	29,600 lm	5,000 K	Black	11-7/16" x 11-7/16" x 7-7/8"	4 ft	Motion sensor
ASD-UHB22-240D50-MS	240W	120-277V	1-10 V	35,520 lm	5,000 K	Black	11-7/16" x 11-7/16" x 7-7/8"	4 ft	Motion sensor

For most up-to-date spec sheets please refer to asd-lighting.com



LED UFO HIGH BAY

PRODUCT SPECIFICATIONS:

Construction & Materials							
Housing	Aluminum						
Lens	Glass 120°			for UHB2-A, UHB2-HE: PC 90°			
Finish	White, Black						
Weight	ASD-UHB2-100D35-PRM	6.2 lbs (2.8 kg)	ASD-UHB2-200D50-PRM	6.2 lbs (2.8 kg)	ASD-UHB2HV-150D50-PRM	6.6 lbs (3 kg)	
	ASD-UHB2-100D50W-PRM		ASD-UHB2-200A50-BK	4.2 lbs (1.9 kg)	ASD-UHB2HV-200D50-PRM	8.8 lbs (4 kg)	
	ASD-UHB2-100D50-PRM		ASD-UHB2-240D50W-PRM	8.2 lbs (3.7 kg)	ASD-UHB2HV-300D50-PRM	13.7 lbs (6.2 kg)	
	ASD-UHB2-150D35-PRM		ASD-UHB2-240D50-PRM	ASD-UHB2-240A50-BK	5.5 lbs (2.5 kg)	ASD-UHB2HV-400D50-PRM	21.6 lbs (9.8 kg)
	ASD-UHB2-150D40W-PRM		ASD-UHB2-300D50-PRM	10.1 lbs (4.6 kg)	ASD-UHB2HV-500D50-PRM	22 lbs (10 kg)	
	ASD-UHB2-150D50W-PRM	ASD-UHB2-400D50-PRM	17 lbs (7.7 kg)	ASD-UHB222-100D50-MS	7.1 lbs (3.2 kg)		
	ASD-UHB2-150D50-PRM	ASD-UHB2-400D50-PRM	ASD-UHB2-400D50-PRM	ASD-UHB222-150D50-MS	9.3 lbs (4.2 kg)		
	ASD-UHB2-150A50-BK	4.2 lbs (1.9 kg)	ASD-UHB2-500D50-PRM	ASD-UHB222-200D50-MS			
	ASD-UHB2-200D35-PRM	6.2 lbs (2.8 kg)	ASD-UHB2-HE-240D50-BK	6.8 lbs (3.1 kg)	ASD-UHB222-240D50-MS		
	ASD-UHB2-200D40W-PRM		ASD-UHB2-HE-500D50-BK	20 lbs (9.1 kg)			
ASD-UHB2-200D50W-PRM	ASD-UHB2-HE-600D50-BK		32.2 lbs (14.6 kg)				
Environmental system							
Work environment	Suitable for Wet Locations, IP65/69K		for UHB2-HE: Suitable for Wet Locations, IP65		for UHB2-A: Suitable for Wet Locations, IP69K		
Operating temperature	-40°F to 149°F (-40°C to 65°C)		for UHB2-A: -40°F to 140°F (-40°C to 60°C)				
L-70 Life	for UHB2: R > 54,000 hrs; C > 152,000 hrs		for UHB2-A, UHB2-HE: R > 54,000 hrs; C > 143,000 hrs		for UHB22: R > 54,000 hrs; C > 145,000 hrs		
	for ASD-UHB2-400D50-PRM, ASD-UHB2-500D50-PRM: R > 60,000 hrs; C > 154,000 hrs		for ASD-UHB2HV-400D50-PRM, ASD-UHB2HV-500D50-PRM: R > 60,000 hrs; C > 143,000 hrs				
Optical system							
Luminous flux	ASD-UHB2-100D35-PRM	14,600 lm	ASD-UHB2-200D50-PRM	29,600 lm	ASD-UHB2HV-150D50-PRM	22,500 lm	
	ASD-UHB2-100D50W-PRM	14,800 lm	ASD-UHB2-200A50-BK	15,885/24,520/30,978 lm	ASD-UHB2HV-200D50-PRM	30,000 lm	
	ASD-UHB2-100D50-PRM		ASD-UHB2-240D50W-PRM	35,520 lm	ASD-UHB2HV-300D50-PRM	45,000 lm	
	ASD-UHB2-150D35-PRM	21,900 lm	ASD-UHB2-240D50-PRM	ASD-UHB2HV-400D50-PRM	56,000 lm		
	ASD-UHB2-150D40W-PRM	22,050 lm	ASD-UHB2-240A50-BK	22,876/30,720/37,120 lm	ASD-UHB2HV-500D50-PRM	70,000 lm	
	ASD-UHB2-150D50W-PRM	22,200 lm	ASD-UHB2-300D50-PRM	45,000 lm	ASD-UHB222-100D50-MS	14,800 lm	
	ASD-UHB2-150D50-PRM		ASD-UHB2-400D50-PRM	60,000 lm	ASD-UHB222-150D50-MS	22,200 lm	
	ASD-UHB2-150A50-BK	15,885/18,982/23,282 lm	ASD-UHB2-500D50-PRM	75,000 lm	ASD-UHB222-200D50-MS	29,600 lm	
	ASD-UHB2-200D35-PRM	29,200 lm	ASD-UHB2-HE-240D50-BK	39,594 lm	ASD-UHB222-240D50-MS	35,520 lm	
	ASD-UHB2-200D40W-PRM	29,400 lm	ASD-UHB2-HE-500D50-BK	82,740 lm			
ASD-UHB2-200D50W-PRM	29,600 lm	ASD-UHB2-HE-600D50-BK	98,935 lm				
Color temperature	3,500 K; 4,000 K; 5,000 K						
CRI	> 70						
Electrical system							
Input voltage	Regular voltage: 120-277 V						
	High voltage: 277-480 V						
Max input current	ASD-UHB2-100D35-PRM	1.3 A	ASD-UHB2-200D50-PRM	2.6 A	ASD-UHB2HV-150D50-PRM	0.8 A	
	ASD-UHB2-100D50W-PRM		ASD-UHB2-200A50-BK	1.9 A	ASD-UHB2HV-200D50-PRM	1.2 A	
	ASD-UHB2-100D50-PRM		ASD-UHB2-240D50W-PRM	2.95 A	ASD-UHB2HV-300D50-PRM		
	ASD-UHB2-150D35-PRM	2 A	ASD-UHB2-240D50-PRM	ASD-UHB2HV-400D50-PRM	1.8 A		
	ASD-UHB2-150D40W-PRM		ASD-UHB2-240A50-BK	2.3 A	ASD-UHB2HV-500D50-PRM		
	ASD-UHB2-150D50W-PRM		ASD-UHB2-300D50-PRM	3.8 A	ASD-UHB222-100D50-MS	1.2 A	
	ASD-UHB2-150D50-PRM	1.4 A	ASD-UHB2-400D50-PRM	4.5 A	ASD-UHB222-150D50-MS	1.8 A	
	ASD-UHB2-150A50-BK		ASD-UHB2-500D50-PRM	5.8 A	ASD-UHB222-200D50-MS	2.4 A	
	ASD-UHB2-200D35-PRM		ASD-UHB2-HE-240D50-BK	2.4 A	ASD-UHB222-240D50-MS	2.8 A	
	ASD-UHB2-200D40W-PRM	2.6 A	ASD-UHB2-HE-500D50-BK	5.8 A			
ASD-UHB2-200D50W-PRM	ASD-UHB2-HE-600D50-BK		7 A				
Inrush current (Action time)	ASD-UHB2-100D35-PRM	80 A (0.5 S)	ASD-UHB2-200D50-PRM	80 A (0.5 S)	ASD-UHB2HV-150D50-PRM	190 A (0.5 S)	
	ASD-UHB2-100D50W-PRM		ASD-UHB2-200A50-BK	94.5 A (0.16 S)	ASD-UHB2HV-200D50-PRM		
	ASD-UHB2-100D50-PRM		ASD-UHB2-240D50W-PRM	80 A (0.5 S)	ASD-UHB2HV-300D50-PRM	90 A (0.5 S)	
	ASD-UHB2-150D35-PRM		ASD-UHB2-240D50-PRM	ASD-UHB2HV-400D50-PRM	50/90 A (0.5 S)		
	ASD-UHB2-150D40W-PRM		ASD-UHB2-240A50-BK	92 A (0.2 S)	ASD-UHB2HV-500D50-PRM		
	ASD-UHB2-150D50W-PRM	88 A (0.12 S)	ASD-UHB2-300D50-PRM	120 A (0.5 S)	ASD-UHB222-100D50-MS	60 A (0.5 S)	
	ASD-UHB2-150D50-PRM		ASD-UHB2-400D50-PRM	60 A (<1 S)	ASD-UHB222-150D50-MS	100 A (0.5 S)	
	ASD-UHB2-150A50-BK		ASD-UHB2-500D50-PRM		ASD-UHB222-200D50-MS		
	ASD-UHB2-200D35-PRM	80 A (0.5 S)	ASD-UHB2-HE-240D50-BK	130 A (0.8 S)	ASD-UHB222-240D50-MS	60 A (0.5 S)	
	ASD-UHB2-200D40W-PRM		ASD-UHB2-HE-500D50-BK	140 A (0.8 S)			
ASD-UHB2-200D50W-PRM	ASD-UHB2-HE-600D50-BK		105 A (1.2 S)				
Off state power	0W						

For most up-to-date spec sheets please refer to asd-lighting.com



LED UFO HIGH BAY

Electrical system						
Power consumption	ASD-UHB2-100D35-PRM	100W	ASD-UHB2-200D50-PRM	200W	ASD-UHB2HV-150D50-PRM	150W
	ASD-UHB2-100D50W-PRM		ASD-UHB2-200A50-BK	100/150/200W	ASD-UHB2HV-200D50-PRM	200W
	ASD-UHB2-150D35-PRM		ASD-UHB2-240D50W-PRM	240W	ASD-UHB2HV-300D50-PRM	300W
	ASD-UHB2-150D40W-PRM	150W	ASD-UHB2-240D50-PRM	150/200/240W	ASD-UHB2HV-400D50-PRM	400W
	ASD-UHB2-150D50W-PRM		ASD-UHB2-300D50-BK	300W	ASD-UHB2HV-500D50-PRM	500W
	ASD-UHB2-150D50-PRM		ASD-UHB2-400D50-PRM	400W	ASD-UHB22-100D50-MS	100W
	ASD-UHB2-150A50-BK	100/120/150W	ASD-UHB2-500D50-PRM	500W	ASD-UHB22-200D50-MS	200W
	ASD-UHB2-200D35-PRM	200W	ASD-UHB2-HE-240D50-BK	240W	ASD-UHB22-240D50-MS	240W
	ASD-UHB2-200D40W-PRM		ASD-UHB2-HE-500D50-BK	500W		
ASD-UHB2-200D50W-PRM	ASD-UHB2-HE-600D50-BK		600W			
Power factor	> 0.9					
Output voltage	ASD-UHB2-100D35-PRM	180-260 V	ASD-UHB2-200D50-PRM	180-260 V	ASD-UHB2HV-150D50-PRM	22-56 V
	ASD-UHB2-100D50-PRM		ASD-UHB2-200A50-BK	252 V	ASD-UHB2HV-200D50-PRM	114-228 V
	ASD-UHB2-100D50W-PRM		ASD-UHB2-240D50W-PRM	180-260 V	ASD-UHB2HV-300D50-PRM	114-228 V
	ASD-UHB2-150D35-PRM	252 V	ASD-UHB2-240D50-PRM	252 V	ASD-UHB2HV-400D50-PRM	22-56 V
	ASD-UHB2-150D40W-PRM		ASD-UHB2-240A50-BK	28-56 V	ASD-UHB2HV-500D50-PRM	90-130 V
	ASD-UHB2-150D50W-PRM		ASD-UHB2-300D50-PRM	171-228 V	ASD-UHB22-100D50-MS	180-260 V
	ASD-UHB2-150D50-PRM	180-260 V	ASD-UHB2-400D50-PRM	114-228 V	ASD-UHB22-200D50-MS	
	ASD-UHB2-150A50-BK		ASD-UHB2-500D50-PRM	238 V	ASD-UHB22-240D50-MS	
	ASD-UHB2-200D35-PRM		ASD-UHB2-HE-240D50-BK	213 V		
ASD-UHB2-200D40W-PRM	0.4 A	ASD-UHB2-HE-600D50-BK	238 V			
ASD-UHB2-200D50W-PRM		ASD-UHB2-200D50-PRM	0.8 A	ASD-UHB2HV-150D50-PRM	2.8 A	
ASD-UHB2-100D35-PRM		ASD-UHB2-200A50-BK	0.76 A	ASD-UHB2HV-200D50-PRM	3.75 A	
ASD-UHB2-100D50W-PRM	0.6 A	ASD-UHB2-240D50W-PRM	0.95 A	ASD-UHB2HV-300D50-PRM	1.25 A	
ASD-UHB2-150D35-PRM		ASD-UHB2-240D50-PRM	0.91 A	ASD-UHB2HV-400D50-PRM	7.5 A	
ASD-UHB2-150D40W-PRM		ASD-UHB2-240A50-BK	0.91 A	ASD-UHB2HV-500D50-PRM	9.4 A	
ASD-UHB2-150D50W-PRM	0.57 A	ASD-UHB2-300D50-PRM	5.6 A	ASD-UHB22-100D50-MS	0.75 A	
ASD-UHB2-150D50-PRM		ASD-UHB2-400D50-PRM	1.75 A	ASD-UHB22-150D50-MS	0.6 A	
ASD-UHB2-150A50-BK		ASD-UHB2-500D50-PRM	2.2 A	ASD-UHB22-200D50-MS		
ASD-UHB2-200D35-PRM	0.8 A	ASD-UHB2-HE-240D50-BK	0.52 A	ASD-UHB22-240D50-MS	1 A	
ASD-UHB2-200D40W-PRM		ASD-UHB2-HE-500D50-BK	2.21 A			
ASD-UHB2-200D50W-PRM		ASD-UHB2-HE-600D50-BK	2.37 A			
Surge protection DM/CM	ASD-UHB2-100D35-PRM	6 kV / 6 kV	ASD-UHB2-200D50-PRM	6 kV / 6 kV	ASD-UHB2HV-150D50-PRM	4 kV / 4 kV
	ASD-UHB2-100D50W-PRM		ASD-UHB2-200A50-BK		ASD-UHB2HV-200D50-PRM	
	ASD-UHB2-100D50-PRM		ASD-UHB2-240D50W-PRM		ASD-UHB2HV-300D50-PRM	
	ASD-UHB2-150D35-PRM	6 kV / 10 kV	ASD-UHB2-240D50-PRM	6 kV / 10 kV	ASD-UHB2HV-400D50-PRM	6 kV / 10 kV
	ASD-UHB2-150D40W-PRM		ASD-UHB2-240A50-BK		ASD-UHB2HV-500D50-PRM	
	ASD-UHB2-150D50W-PRM		ASD-UHB2-300D50-PRM		ASD-UHB22-100D50-MS	
	ASD-UHB2-150D50-PRM	6 kV / 6 kV	ASD-UHB2-400D50-PRM	6 kV / 6 kV	ASD-UHB22-150D50-MS	6 kV / 6 kV
	ASD-UHB2-150A50-BK		ASD-UHB2-500D50-PRM		ASD-UHB22-200D50-MS	
	ASD-UHB2-200D35-PRM		ASD-UHB2-HE-240D50-BK		ASD-UHB22-240D50-MS	
	ASD-UHB2-200D40W-PRM	10 kV / 6 kV	ASD-UHB2-HE-500D50-BK	10 kV / 6 kV		
	ASD-UHB2-200D50W-PRM		ASD-UHB2-HE-600D50-BK			
	ASD-UHB2-200D50-PRM					

Regular and voluntary certifications		Dimming compatible controls **					
5-year limited warranty		Brand	Maxxima	Keygma	Lutron	Leviton	Eaton
DesignLights Consortium (DLC) listed (Classification: Premium) Main: Indoor luminaires; General application: High-bay; Primary use: High-bay luminaires for commercial and industrial buildings.		Models	MEW-DM600LV	KGM-1A010V	DVSTV-WH	IP710-DLZ	DF10P-C1
UL certified E473804 cETLus certified (for UHB2-HE)		Dimming compatible controls ***					
		Brand	Leviton		Lutron		
		Models	ZS057-D0Z	DD710	MS-Z101	NTSTV	
			DS710	IP710	DVSTV	DVTV	

* Under extreme conditions fixture may enter protection mode. If ambient temperature exceeds 140°F (60°C) for an extended period lumen output will decrease to 60% capacity. At higher sustained temperatures protection mode will terminate power to the fixture.

** The list of dimmers is relevant for models without a motion sensor.

*** The list of dimmers is relevant for UHB2-A models.

PACKAGE CONTENTS FOR UHB2:

Description	Q-ty
LED UFO High Bay Fixture	1
Bracket (A) only for HE-600W, HV-300W, HV-400W, HV-500W models	1
Safety cable (B)	1
Mounting ring (C)	1
Spring hook M20 (D) only for HV-400W, HV-500W models	1
Box	1

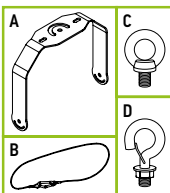

PACKAGE CONTENTS FOR UHB2:

Description	Q-ty
LED UFO High Bay Fixture	1
Safety cable (A)	1
Mounting ring (B)	1
Screw for reflector installation (C)*	1
Box	1

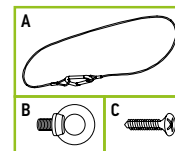

* Screws are already installed in the attachment points of the UFO housing.

For most up-to-date spec sheets please refer to asd-lighting.com



LED UFO HIGH BAY

ACCESSORIES (sold separately):

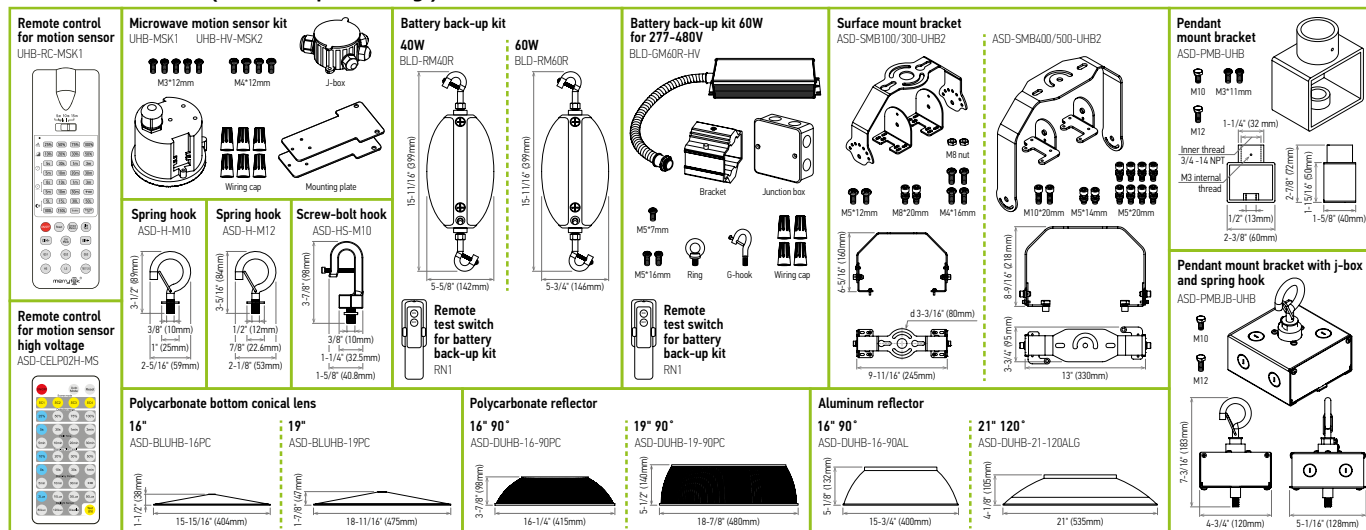

Remote control for motion sensor
UHB-RC-MSK1

Microwave motion sensor kit
UHB-MSK1 UHB-HV-MSK2
M4*12mm M4*12mm J-box
Wiring cap Mounting plate

Battery back-up kit
40W BLD-RM40R 60W BLD-RM60R
15-11/16" (99mm) 15-11/16" (99mm)
5-5/8" (142mm) 5-3/4" (144mm)

Battery back-up kit 60W for 277-480V
BLD-GM60R-HV
M5*7mm M5*16mm Ring G-hook Wiring cap

Surface mount bracket
ASD-SMB100/300-UHB2 ASD-SMB400/500-UHB2
M8 nut M5*12mm M8*20mm M4*16mm M10*20mm M5*14mm M5*20mm
6-5/16" (166mm) 8-9/16" (218mm) 3-3/4" (95mm) 13" (330mm)
d3-3/16" (80mm) 9-11/16" (245mm)

Pendant mount bracket
ASD-PMB-UHB
M10 M5*11mm M12 1-1/4" (32mm) 3/4"-14 NPT 1-3/16" (39mm) 1/2" (13mm) 2-3/8" (60mm) 1-5/8" (40mm)

Pendant mount bracket with j-box and spring hook
ASD-PMB-JB-UHB
M10 M12 7-3/16" (188mm) 4-3/4" (120mm) 5-1/16" (128mm)

Remote control for motion sensor high voltage
ASD-CELP02H-MS

Spring hook
ASD-H-M10 3-1/2" (89mm) 3/8" (10mm) 2-5/16" (59mm)
ASD-H-M12 3-5/16" (86mm) 1/2" (12mm) 2-1/8" (53mm)

Screw-bolt hook
ASD-HS-M10 3/8" (10mm) 1-1/4" (32mm) 1-5/8" (40.8mm)

Remote test switch for battery back-up kit
RN1

Remote test switch for battery back-up kit
RN1

Polycarbonate bottom conical lens
16" ASD-BLUHB-16PC 1-1/2" (38mm) 15-15/16" (404mm)
19" ASD-BLUHB-19PC 1-7/8" (47mm) 18-11/16" (475mm)

Polycarbonate reflector
16" 90° ASD-DUHB-16-90PC 3-7/8" (98mm) 16-1/4" (415mm)
19" 90° ASD-DUHB-19-90PC 5-1/2" (140mm) 18-7/8" (480mm)

Aluminum reflector
16" 90° ASD-DUHB-16-90AL 5-1/2" (142mm) 15-3/4" (400mm)
21" 120° ASD-DUHB-21-120ALG 4-7/8" (125mm) 21" (535mm)

ACCESSORY COMPATIBILITY LIST:

Models	Accessories	Microwave motion sensor kit UHB-MSK1	Microwave motion sensor kit for 277-480V UHBHV-MSK2	Remote control for motion sensor UHB-RC-MSK1	Battery back-up kit 40W BLD-RM40R	Battery back-up kit 60W BLD-RM60R	Battery back-up kit 60W for 277-480V BLD-GM60R-HV	Spring hook M10 ASD-H-M10	Screw-bolt hook M10 ASD-HS-M10	Spring hook M12 ASD-H-M12	Pendant mount bracket ASD-PMB-UHB	Pendant mount bracket with J-box and spring hook ASD-PMB-JB-UHB	Surface mount bracket ASD-SMB100/300-UHB2	Surface mount bracket ASD-SMB400/500-UHB2	Polycarbonate bottom conical lens for 16" ASD-BLUHB-16PC	Polycarbonate bottom conical lens for 19" ASD-BLUHB-19PC	Polycarbonate reflector 16" ASD-DUHB-16-90PC	Polycarbonate reflector 19" ASD-DUHB-19-90PC	Aluminum reflector 16" ASD-DUHB-16-90AL	Aluminum reflector 21" ASD-DUHB-21-120ALG	
		ASD-UHB2	100W	•			•			•	•		•	•	•	•	•	•	•	•	•
	150W	•			•			•	•		•	•	•	•	•	•	•	•	•	•	•
	100/120/150W	•			•			•	•		•	•	•	•	•	•	•	•	•	•	•
	200W	•			•			•	•		•	•	•	•	•	•	•	•	•	•	•
	100/150/200W	•			•			•	•		•	•	•	•	•	•	•	•	•	•	•
	240W	•			•			•	•		•	•	•	•	•	•	•	•	•	•	•
	150/200/240W	•			•			•	•		•	•	•	•	•	•	•	•	•	•	•
	300W	•			•			•	•	•	•	•	•	•	•	•	•	•	•	•	•
	400W	•			•			•	•		•	•	•	•	•	•	•	•	•	•	•
	500W	•			•			•	•		•	•	•	•	•	•	•	•	•	•	•
ASD-UHB2-HE	240W				•			•	•		•	•	•	•	•	•	•	•	•	•	•
	500W				•			•	•		•	•	•	•	•	•	•	•	•	•	•
	600W																				
ASD-UHB2HV	150W		•					•	•		•	•	•	•	•	•	•	•	•	•	•
	200W		•					•	•		•	•	•	•	•	•	•	•	•	•	•
	300W		•					•	•		•	•	•	•	•	•	•	•	•	•	•
	400W		•					•	•		•	•	•	•	•	•	•	•	•	•	•
	500W		•					•	•		•	•	•	•	•	•	•	•	•	•	•
ASD-UHB22-MS				•				•	•		•	•	•	•	•	•	•	•	•	•	•

Note: Battery back-up kit and the Motion sensor kit can not work together. Please install one at a time.

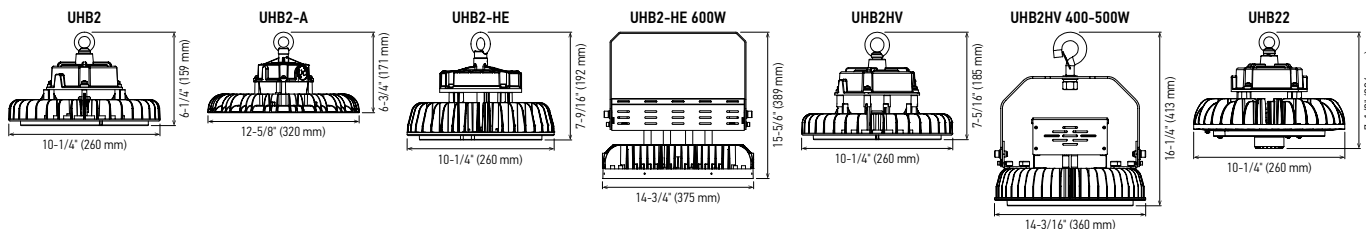

For most up-to-date spec sheets please refer to asd-lighting.com



LED UFO HIGH BAY

BUILT-IN MOTION SENSOR INFORMATION



UHB22-MS series



remote control
UHB-RC-MSK1
(sold separately)

- ▶ Sensor parameters can be conveniently set via remote control (sold separately)
- ▶ Mounting height up to 49.2ft (15m) max, suitable for warehouse use
- ▶ Built-in adjustable daylight sensor

Coverage area for ceiling mounting:

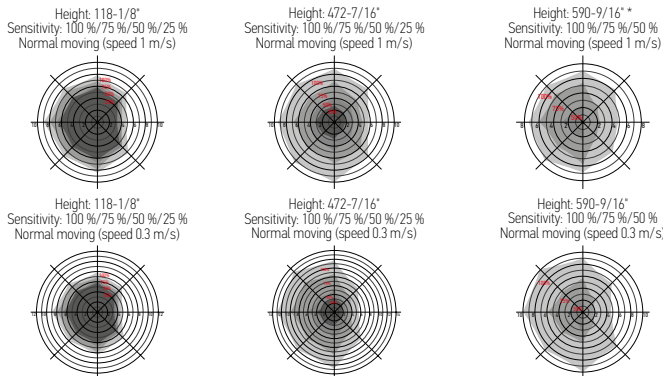

* Only 100%/75%/50% detection sensitivity is workable when installed at 590-9/16" mounting height
25% sensitivity is not able to detect motion signal.

Specifications	Model: MCD79D RC2B
Operating voltage	12 Vdc ± 1 V
Operating current	25 mA
Working mode	0-10 Vdc
Detection area	25 %/50 %/75 %/100 %
Hold time	5 s/1 min/3 min/5 min/10 min/20 min/30 min
Daylight threshold	5 lux (0.5 fc)/15 lux (1.4 fc)/30 lux (2.8 fc)/50 lux (4.7 fc)/100 lux (9.3 fc)/150 lux (14 fc)/Disable
Standby period	0 s/10 s/1 min/3 min/5 min/10 min/30 min/+ ∞
Standby dimming level	10 %/20 %/30 %/50 %
Operating frequency	5.8 GHz ± 75 MHz, ISM band
Transmitting power	1 mW max
Stand-by power	< 0.3 mW
Mounting height	max 49.2 ft (15 m)
Detection range	max 39.37 ft (12 m)

DEFAULT SETTING:

Detection area	Hold time	Daylight sensor	Stand-by period	Stand-by dim level	Sensitivity
100 %	20 min	Disable	0 s	10 %	Low (LS)

⚠ RF interference may affect the operation of this sensor.

Coverage area for wall mounting:

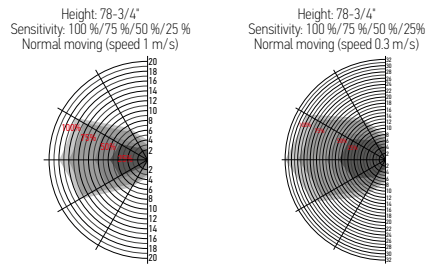

MOTION SENSOR KIT INFORMATION



UHB-MSK Motion sensor kit for 120-277V



remote control
UHB-RC-MSK1
(sold separately)

- ▶ Sensor parameters can be conveniently set via remote control (sold separately)
- ▶ Mounting height up to 50 ft max., suitable for warehouse use
- ▶ Water proof sensor with IP65 rating
- ▶ 3-step dimming when used in combination with 1-10 V dimmable LED drivers



UHBHV-MSK2 Motion sensor kit for 347-480V



remote control
ASD-CELP02H-MS
(sold separately)

- ▶ Built-in adjustable daylight sensor
- ▶ 1-10 V interface can match up with Merrytek stand-alone daylight sensor MS01 to achieve daylight harvesting
- ▶ Optional mounting brackets for different applications

Specifications	Model: UHB-MSK1 (sold separately)				Model: UHBHV-MSK2 (sold separately)		
For fixture models	ASD-UHB2-100D35-PRM ASD-UHB2-100D50-PRM ASD-UHB2-100D50W-PRM ASD-UHB2-150D35-PRM	ASD-UHB2-150D40W-PRM ASD-UHB2-150D50-PRM ASD-UHB2-150D50W-PRM	ASD-UHB2-200D35-PRM ASD-UHB2-200D40W-PRM ASD-UHB2-200D50-PRM	ASD-UHB2-200D50W-PRM ASD-UHB2-240D50-PRM ASD-UHB2-240D50W-PRM	ASD-UHB2-300D50-PRM ASD-UHB2-400D50-PRM ASD-UHB2-500D50-PRM	ASD-UHB2HV-150D50-PRM ASD-UHB2HV-200D50-PRM ASD-UHB2HV-300D50-PRM	ASD-UHB2HV-400D50-PRM ASD-UHB2HV-500D50-PRM
Rated load	120 Vac - 400W max; 277 Vac - 800W max				277 Vac - 800W max; 480 Vac - 1200W max		
Detection area	25 %/50 %/75 %/100 %						
Hold time	5 s/30 s/1 min/3 min/5 min/10 min/20 min/30 min						
Daylight sensor	5 lux (0.5 fc)/15 lux (1.4 fc)/30 lux (2.8 fc)/50 lux (4.7 fc)/100 lux (9.3 fc)/150 lux (14 fc)/disable				2 lux (0.2 fc)/10 lux (0.9 fc)/30 lux (2.8 fc)/50 lux (4.7 fc)/80 lux (7.4 fc)/120 lux (11.2 fc)/disable		
Stand by power	< 1W						
Stand by period	0 s/10 s/1 min/3 min/5 min/10 min/30 min/+ ∞						
Stand by dimming level	10 %/20 %/30 %/50 %						
Sensor principle	Microwave motion detector						
Microwave frequency	5.8 GHz ± 75 MHz, ISM wave band						
Transmitting power	<0.5 mW (1 % of transmitting power for cell phone)				<1 mW (1 % of transmitting power for cell phone)		
Mounting height	10-50 ft (3-15 m)						
Detection angle	150° (wall installation); 360° (ceiling installation)						
Motion detection	0.5-3 m/s						
Operating temperature	-31 to 158°F (-35°C to 70°C)						
IP rating	IP65						

⚠ RF interference may affect the operation of this sensor

For most up-to-date spec sheets please refer to asd-lighting.com



LED UFO HIGH BAY

Coverage area for ceiling mounting:

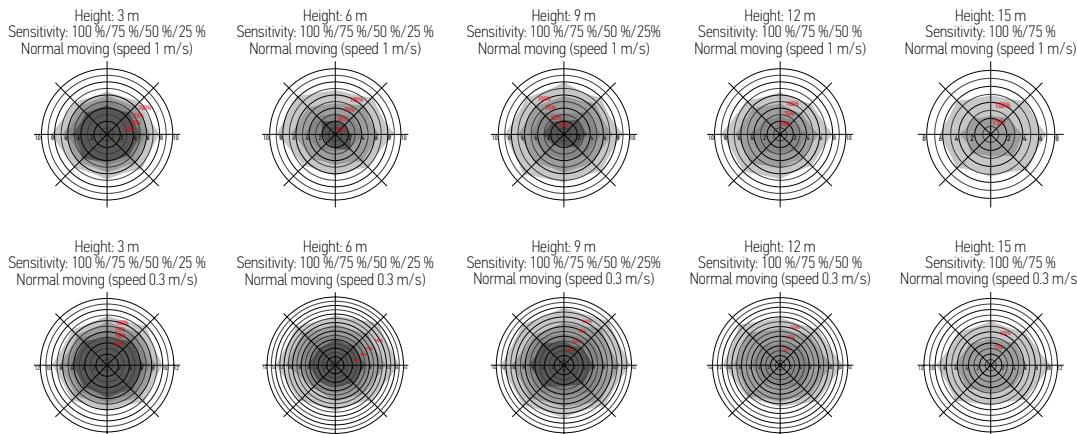

Coverage area for wall mounting:

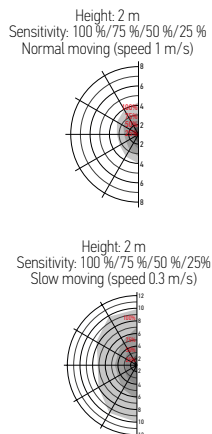

* Only 100 %/75 %/50 % detection sensitivity is workable when installed at 10 m & 15 m mounting height 25 % sensitivity is not able to detect motion signal.

REMOTE CONTROL UHB-RC-MSK1 sold separately:

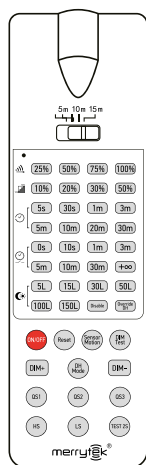

Button	Remarks
ON/OFF	Press the "ON/OFF" button: the fixture will switch to the constant on/off mode. Use ON/OFF button to on and off the fixture. Press any another button to switch back to the motion sensor mode.
Reset	Press "Reset" button: all parameters are the same as the DIP switch or factory settings.
Sensor motion	Press "Sensor motion" button, the light quits from the constant on/off mode, and the sensor starts to work (The latest setting stays in validity).
Dim test	Press "Dim test" button: the 0-10 V dimming works to test whether the 0-10 V dc dimming ports are connected properly. After 2 s, it returns to the latest setting automatically.
Override DH	Hold for 3 s: daylight priority mode will be switched to daylight threshold mode with the preset daylight value.
DIM + / DIM -	Set occupancy light level in range of 50 % - 100 %. Dim level changes by 2 % each time Dim + / Dim - is pressed.
DH Mode	Hold for 3 s: sensor will be switched to daylight priority mode, if the preset daylight value is set to "Disable" the sensor will stay in daylight threshold mode.
Escena option	Detection area Hold time Standby period Standby dim level Daylight sensor Induction model
QS1	100 % 5 min 10 min 10 % 30 lux (2.8 fc) HS
QS2	100 % 10 min 30 min 10 % Disable HS
QS3	100 % 20 min 30 min 10 % Disable HS
Test 2 s	Press the "Test 2 s" button at any time to enter test mode. In this mode the sensor parameters are as follows: Detection area is 100 %, Hold time is 5 s, Standby dim level is 10 %, Standby period is 0 s, daylight sensor is disabled. This function is only for testing. Press "Reset" or any other function button to exit this mode.
HS / LS	Press the "HS" button for high sensitivity in the detection area. Press the "LS" button for low sensitivity in the detection area. The adjustment is based on the "Detection area" parameter you set.
Daylight sensor	Set up daylight threshold: 5 lux (0.5 fc)/15 lux (1.4 fc)/30 lux (2.8 fc)/50 lux (4.7 fc)/100 lux (9.3 fc)/150 lux (14 fc)/disable
Standby dim level	Set up standby dim level: 10 %/20 %/30 %/50 %
Standby period	Set up standby time: 0 s/10 s/1 min/3 min/5 min/10 min/30 min/+ ∞
Detection area	Set up detection area: 25 %/50 %/75 %/100 %
Hold time	Set up hold-time: 5 s/30 s/1 min/3 min/5 min/10 min/20 min/30 min
Remote distance	Toggle the button to set the remote distance of remote control and sensor.

Remote control and code setting conversion:

1. DIP switch settings convert to remote control: Press any button except "Reset" on the remote control, and the sensor settings convert to the function currently selected by the remote control. (No function button settings invalid).

2. Remote control convert to DIP switch settings:

a. Press the "Reset" button on the remote control, and all settings return to the DIP switch settings of the sensor.

b. Turn off the power, toggle any DIP switch, connect to the power, and all settings return to the DIP switch settings when power is supplied again.

To manually set your fixture use the top set of buttons on your wireless remote control. There are 5 sets of parameters to set.

Detection area – sensitivity of motion sensor in percent.

Hold time – time the fixture will remain at full brightness after no motion is detected.

Stand by time – time fixture will remain on at a reduced brightness.

Stand by dim level – light output level after hold time expires and stand by time starts.

Daylight threshold – fixture can be set to adjust light output based on ambient light levels in the area.

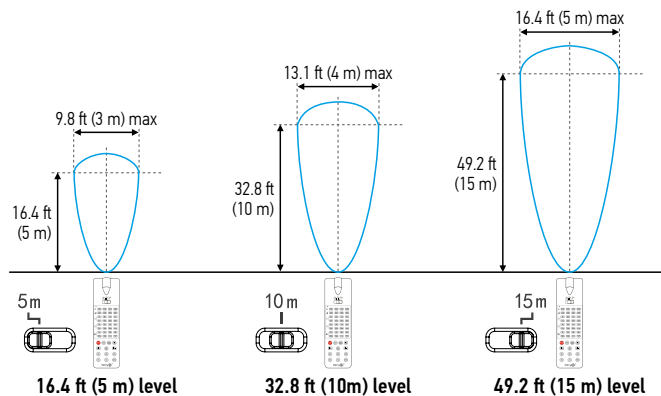

For most up-to-date spec sheets please refer to asd-lighting.com







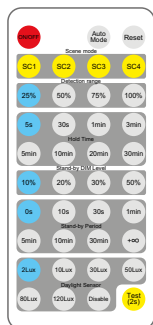

LED UFO HIGH BAY

REMOTE CONTROL ASD-CELPO2H-MS sold separately:



Remote control range is 10 ft, every fixture needs to be set up separately

Button	Remarks																													
ON/OFF	Press the "ON/OFF" button; the light stays permanently on or off. * Press "Auto Mode", "Reset" or "Scene mode" buttons to quit this mode.																													
Auto mode	Press "Auto mode" button; the sensor starts to work and all settings remain the same as before the light was switched on/off.																													
Reset	Press "Reset" button; products with DIP switch will be controlled by DIP switches																													
Scene mode	<table border="1"> <thead> <tr> <th>Detection area</th> <th>Hold time</th> <th>Daylight threshold</th> <th>Standby period</th> <th>Standby dimming level</th> </tr> </thead> <tbody> <tr> <td>SC1</td> <td>100 %</td> <td>30 s</td> <td>2 lux (0.2 fc)</td> <td>1 min</td> <td>10 %</td> </tr> <tr> <td>SC2</td> <td>100 %</td> <td>5 min</td> <td>10 lux (1 fc)</td> <td>10 min</td> <td>10 %</td> </tr> <tr> <td>SC3</td> <td>100 %</td> <td>10 min</td> <td>50 lux (5 fc)</td> <td>30 min</td> <td>10 %</td> </tr> <tr> <td>SC4</td> <td>100 %</td> <td>30 min</td> <td>Disable</td> <td>+ ∞</td> <td>10 %</td> </tr> </tbody> </table>	Detection area	Hold time	Daylight threshold	Standby period	Standby dimming level	SC1	100 %	30 s	2 lux (0.2 fc)	1 min	10 %	SC2	100 %	5 min	10 lux (1 fc)	10 min	10 %	SC3	100 %	10 min	50 lux (5 fc)	30 min	10 %	SC4	100 %	30 min	Disable	+ ∞	10 %
Detection area	Hold time	Daylight threshold	Standby period	Standby dimming level																										
SC1	100 %	30 s	2 lux (0.2 fc)	1 min	10 %																									
SC2	100 %	5 min	10 lux (1 fc)	10 min	10 %																									
SC3	100 %	10 min	50 lux (5 fc)	30 min	10 %																									
SC4	100 %	30 min	Disable	+ ∞	10 %																									
Test (2 S)	The button "Test (2s)" is for testing purposes only. After pressing this button, the sensor goes to test mode (hold time is only 2s) automatically, standby period and daylight sensor are disabled. This mode can be ended by pressing "Reset", "Auto mode", "Scene mode" or "Hold time". The sensor settings are changed accordingly. Brightness settings: Disable Test mode (can press any key to exit this mode).																													
 ON/OFF control	There are 4 fixed scene mode programs built into the remote control to choose for different applications.	 Daylight threshold	Press the button "Daylight sensor" to set daylight threshold as 2 lux (0.2 fc)/ 10 lux (1 fc)/30 lux (3 fc)/50 lux (5 fc)/80 lux (8 fc)/120 lux (11 fc)/disable																											
 Detection area	Press the button "Detection range" to set detection range as 100%/75%/50%/10%	 Stand-by period	Press the button "Stand-by period" to set standby period as 0 s/10 s/30 s/1 min/5 min/10 min/30 min/+ ∞. Note: "0 s" means on/off control; "+ ∞" means bi-level dimming control.																											
 Hold time	Press the button "Hold time" to set hold-time as 5 s/30 s/1 min/3 min/5 min/10 min/20 min/30 min.	 Stand-by dimming	Press the button "Stand-by dimming level" to set the standby dimming level as 10%/20%/30%/50%.																											

2-STEP DIMMING FUNCTION (STAND BY PERIOD BE SET TO "+ ∞")

1. If there is no motion detected, the light will be remained at a low light level all the time.
2. When motion is detected, the sensor will switch on the light to 100 % brightness.
3. After elapse of hold time, the sensor dims the light at the present low light level if no motion is detected.

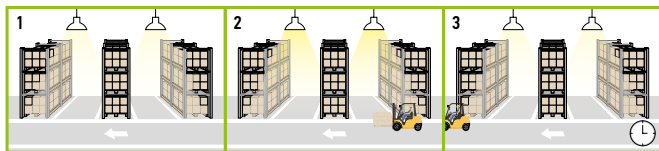

3-STEP DIMMING FUNCTION (STAND BY PERIOD BE SET TO "10 S/1 MIN/3 MIN/5 MIN/10 MIN/30 MIN")

1. With sufficient ambient light, the light will not be switched on even with the motion sensor activated.
2. With insufficient ambient light, the sensor will switch on the light when motion is detected.
3. After elapse of hold time, the sensor will dim the light if no new motion is detected.
4. After elapse of stand by period, the sensor switches off the light if no motion is detected.

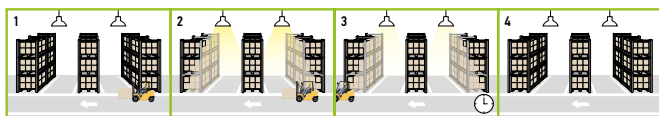

DAYLIGHT PRIORITY (STAND BY PERIOD SET TO "+ ∞")

1. Lamp turns on at 10 % at night.
2. When motion is detected, lamp automatically lights up to 100 %.
3. After hold time, the lamp gradually dims to 10 % if no movement is detected.
4. Lamp turns off after dawn.

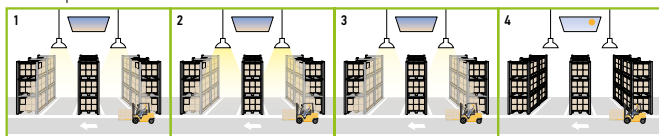

To avoid blocking the microwave emission, the microwave sensor can not be covered with metal materials, be sprayed with a coating of metal components, or have attached metal material or stickers etc.

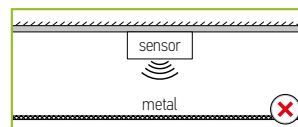

The distance between the antenna and the glass (dielectric material) should be no less than 0.4ft when the sensor is within the glass lampshade. Otherwise, the microwave motion sensor will not penetrate the glass easily.

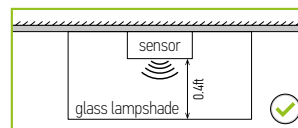

Avoid placing the sensor inside a metal chamber, this may cause a mis-trigger.

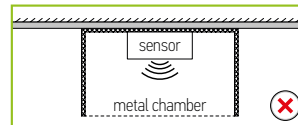

The sensor should not be placed in a small confined space. To avoid increasing the sensor detection range or abnormal operation, the sensor should be kept away from large areas of metal and glass reflectors (separation distance at least 3.3ft). Reduce the detection area setting.

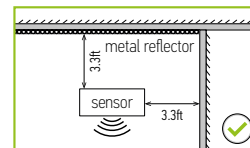

To avoid affecting the microwave signal transmission, the microwave antenna should be higher than the surrounding metal surface.

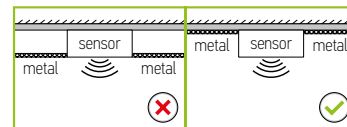

Any vibration or movement may trigger the sensor. Ensure the sensor is far from any constant movement.

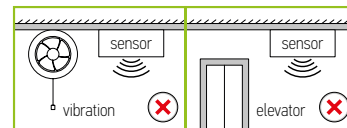

When multiple sensors are installed side-by-side in the same direction, the distance between each sensor should be at least 3.3ft (the warehouse sensors at least 9.8ft) to avoid mutual interference.

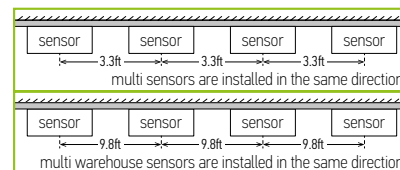

For most up-to-date spec sheets please refer to asd-lighting.com



LED UFO HIGH BAY

BATTERY BACK-UP KIT INFORMATION

BLD-RM40R BLD-RM60R sold separately:

BLD-RM40R, BLD-RM60R listed for field and factory installation, provides constant power output to the load during emergency mode operation. They maintain illumination in emergency mode for a minimum of 90 minutes. It is an ideal emergency solution for UFO LED highbay lights.

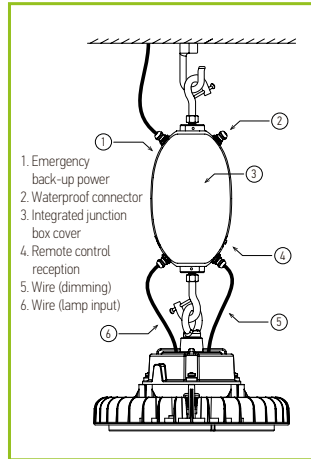

BLD-GM60R-HV sold separately:

BLD-GM60R-HV listed for field and factory installation, provides constant power output to the load during emergency mode operation. It maintains illumination in emergency mode for a minimum of 90 minutes. It is an ideal emergency solution for UFO LED highbay lights.

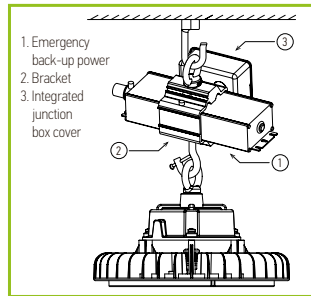
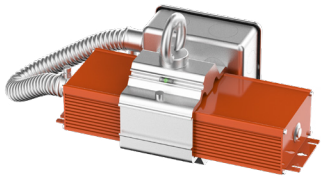

Specifications	BLD-RM40R	BLD-RM60R	BLD-GM60R-HV
Input voltage	100-347 V		277-480 V
Input current	≤ 200 mA		max 100 mA
Input power	max 15W		max 20W
Standby input power	< 0.8W (finished charging)		< 6W (finished charging)
Maximum standby time between recharges	6 months		
Driver type	Constant power		
Output power (emergency mode)	40W	60W	
Output voltage range	≤ 170 Vdc		400 Vdc
Lumens	6,000 lm		
Maximum load power	300W (when dimming to a minimum, the power needs to be less than 36W)		
Peak output power (emergency mode)	100W (lasts for 10 seconds)		65W
Number of output channels	1 channel		
RFI/EMI	FCC part 15 class B		
Output type	LED class 1		
Battery type	Li-ion		
Battery capacity available	2600 mAh (96 WH)		4000 mAh (115 WH)
Battery recharge time	24 hours		
Battery discharge time	90 min		
Maximum lighting fixture weight	44.1 lbs (20 kg)		44.1 lbs (20 kg)
Self-diagnostic test system	<p>In the normal charging mode, the system performs a self-diagnostic test every 30 days, the system switches to emergency mode for 30S, and then automatically switches back to the normal charging mode.</p> <p>In the normal charging mode, the system switches to emergency mode every 360 days (after 11 monthly self-diagnostic test) and works until the end of discharge. Automatically switches back to normal charging mode after discharge.</p>		
Operating temperature	-32°F to 122°F (0°C to 50°C)		40°F to 122°F (5°C to 50°C)
Service life	50,000 hours		
Input surge protection	2 kV		
Protections	Battery over discharge protection, output short circuit protection		
Approvals/class	RoHS, UL924 listed, CEC title 20 Dry/Wet Locations, IP65		

STANDARD OPERATION DISPLAY STATUS:

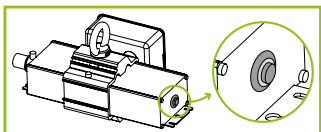

Charging	
Emergency mode	

AC operation: AC power is present. The AC driver operates the LED load as designed. The emergency driver is charging in standby mode. The charging indicator will be lit, showing that the battery is charging.

Emergency operation: When the AC power goes out, the emergency driver detects the AC power outage and automatically switches to emergency mode. When red LED light is OFF, that means driver is discharging. When the AC power is restored, the emergency driver goes back to AC power and starts recharging.

REMOTE TEST SWITCH

RN1 sold separately:

- ▶ Press the ON button to switch battery to the back-up mode. The indicator light will turn off and fixture will decrease light output.
- ▶ Press OFF to switch the fixture to normal operation mode.



For most up-to-date spec sheets please refer to asd-lighting.com



LED UFO HIGH BAY

INSTALLATION GUIDE

IMPORTANT SAFETY INFORMATION:

Please read all the instructions below before installation.

- ▶ Make sure that the supply voltage corresponds to the rated product voltage.
- ▶ The product must be installed by a qualified electrician in accordance with the National Electrical Code and corresponding local codes.
- ▶ If the product is damaged, do not use it.

ELECTRICAL SCHEMATIC DIAGRAM:

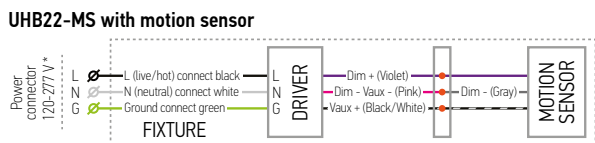
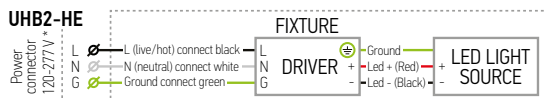
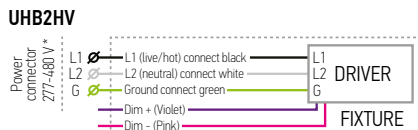
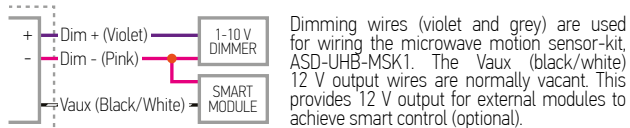
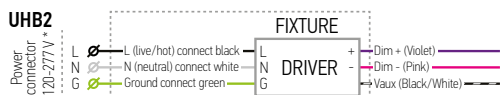

The sensor is designed to operate with a single fixture. Connecting multiple fixtures can damage the sensor.

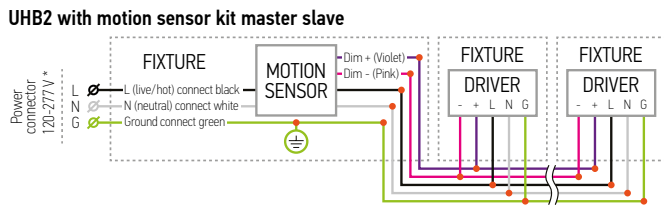
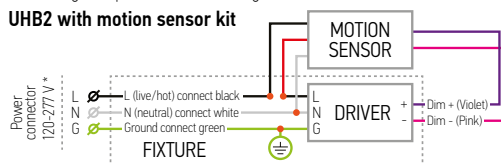

Model		100W	150W	200W	240W	300W	400W	500W
UHB-MSK1	120 V	3	2	1	1	1	0	0
	277 V	6	4	3	2	2	1	1
Model HV		150W	200W	300W	400W	500W		
UHBHV-MSK1	277 V	4	3	2	1	1		
	480 V	6	4	3	2	1		

⚠ WARNING

RISK OF PERSONAL INJURY – READ and follow all WARNINGS and installation instructions. Keep or give to the owner for future reference.

Risk of cuts: Wear gloves to prevent cuts or abrasions when removing from carton, handling, installing, and maintaining this product.

Risk of electric shock: This product must be installed in accordance with the applicable installation code by a person familiar with the construction and operation of the product and the hazards involved.

Risk of Fire: Minimum 194°F supply conductors. Consult a qualified electrician to ensure correct branch circuit conductor.

ASD® assumes no responsibility for claims arising out of improper or careless installation or handling of this product.

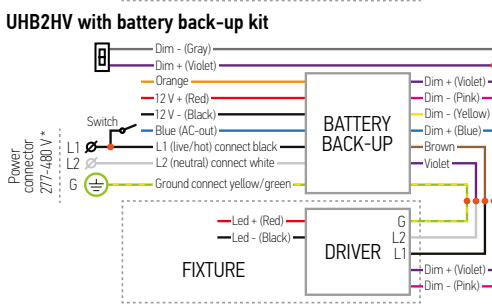
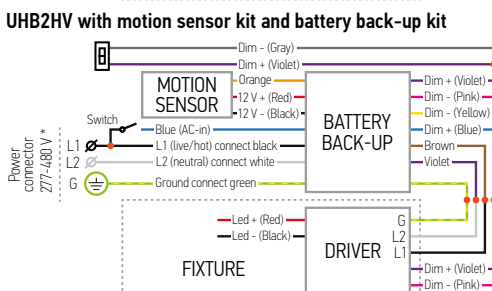
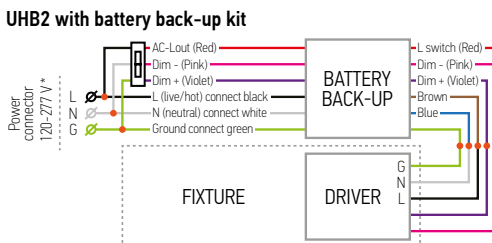
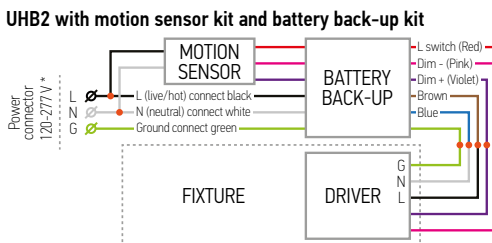

For most up-to-date spec sheets please refer to asd-lighting.com



ASD[®] LED UFO HIGH BAY

INSTALLATION STEPS:

1. Screw on the mounting ring (included) and tighten it.
2. Clip the fixture on the hook in the ceiling using the mounting ring. Secure the luminaire with a safety cable.
3. Connect the wires: Black to Black, White to White, Green to Green. Secure the connection with wire nuts.

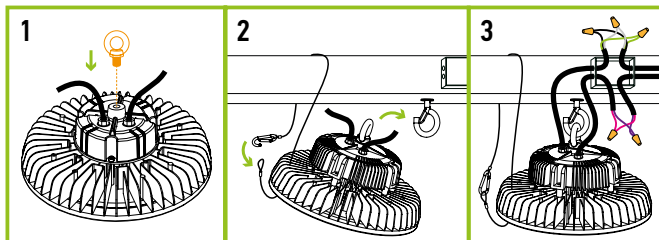

UHB2-HE with battery back-up kit

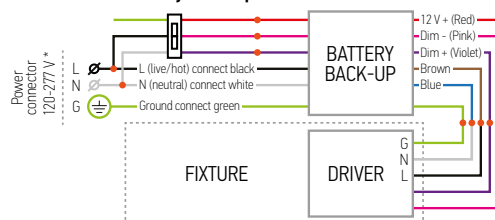

* The regular voltage 120-277 V fixtures can be alternatively powered without neutral by two-phase circuit with phase-to-phase voltage of 208V (L1-120 V & L2-120 V).
WARNING: Phase-to-phase voltage should be less than 277 V (160 V per each phase) and more than 120 V (70 V per each phase)! Do not confuse Regular Voltage fixtures of 120-277 V with High Voltage ones of 277-480 V!

PENDANT MOUNT BRACKET INSTALLATION

ASD-PMB-UHB sold separately:

1. Remove the original ring from the driver.
2. Install the adapter and secure it to the driver using a M10 or M12 screw (included with the adapter).
3. Screw the adapter with the fixture onto a pole and secure it with an M3 screw (included with the adapter).

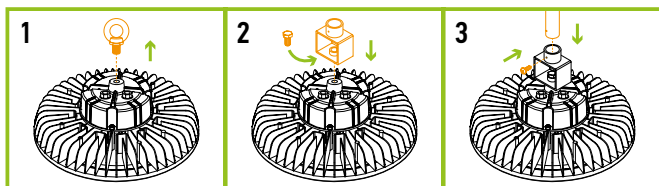

SURFACE MOUNT BRACKET INSTALLATION FOR 100-300W FIXTURES

ASD-SMB100/300-UHB2 sold separately:

1. Use four PM5x5/8" screws (included) to install bracket swivel on the top of the lamp body.
2. Use two PM5x7/16" screws (included) to fix bracket on the swivels.
3. Adjust the light direction and fix it using two M8x13/16" screws (included).

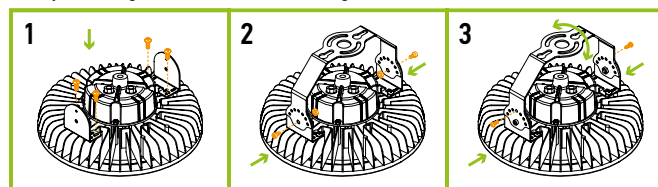

PENDANT MOUNT BRACKET WITH J-BOX AND SPRING HOOK INSTALLATION

ASD-PMBJB-UHB sold separately:

1. Uninstall the mounting ring from the fixture. Unscrew 2 screws and open side plate of the Pendant Junction box. Install M10 or M12 Mounting screw depending of the fixture's thread size.
2. **Mounting hook installation:** Loosen security screw and install the spring hook to the upper installation hole of the Pendant J-box and secure it by screw. Secure Pendant J-box to the fixture, and then secure to the ceiling. Close side plate back.
3. **Pendant installation:** Uninstall adapter from pole mounting hole. Secure the Pendant J-box with fixture to the pole. Secure fixture to the Pendant J-box. Close side plate back.

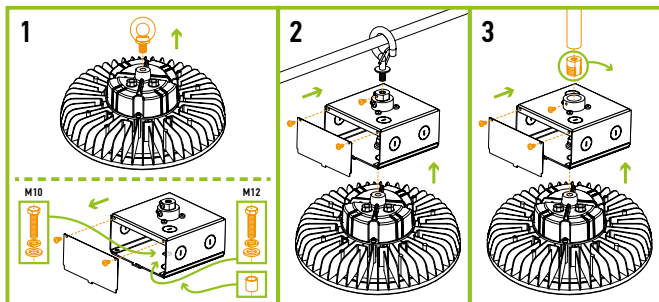

SURFACE MOUNT BRACKET INSTALLATION FOR 400-500W FIXTURES

ASD-SMB400/500-UHB2 sold separately:

1. Use four M5x13/16" screws (included) to install bracket swivel on the top of the lamp body.
2. Use two M10x13/16" and M5x9/16" screws (included) to fix bracket on the swivels.
3. Adjust the light direction and fix it using two M8x13/16" screws (included).

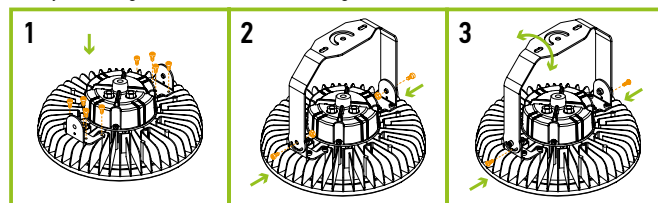

POWER SETTINGS:

Unscrew the knock out on the driver box and adjust power by simple switch.

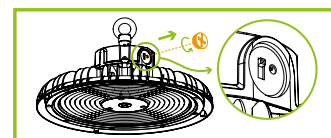

For most up-to-date spec sheets please refer to asd-lighting.com



LED UFO HIGH BAY

BATTERY BACK-UP KIT INSTALLATION

BLD-RM40R **BLD-RM60R** sold separately:

1. Install the G-hook to the top thread hole of the battery back-up and secure with the screw. Attach the battery back-up with G-hook to the ceiling hook.
2. Loosen the screw on the enclosed hook on the bottom of the emergency back-up, attach the ring on the fixture to the hook and tighten screw back. Open the cover and remove the plastic covers and install the five waterproof connectors.
3. Pull all wires through the waterproof connectors into the chamber of emergency driver. Connect wires: Brown, Blue, Green with AC input wires of the fixture. Connect dimming wires Purple and Pink with LED driver input dimming wires. Connect Black, White and Red wires of the battery back-up with AC main Power cord. Secure connection with wire nuts and lock up the cover of junction box.

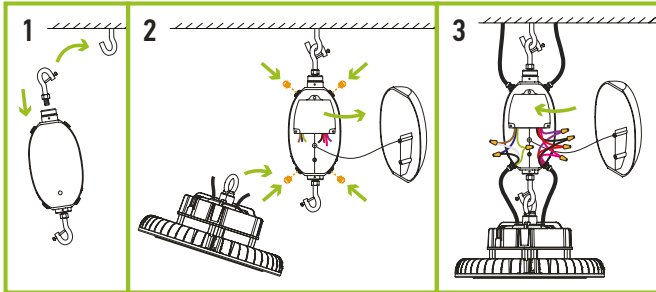

DIFFUSER AND LENS INSTALLATION

ASD-DUHB-16-90PC **ASD-DUHB-19-90PC**
ASD-DUHB-16-90AL **ASD-DUHB-21-120ALG**
ASD-BLUHB-16PC **ASD-BLUHB-19PC** sold separately:

1. Install the diffuser, tighten the screws.
2. Attach the conical lens to the included clamp.

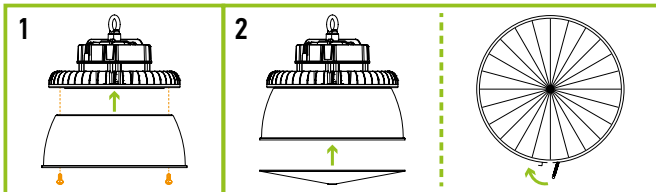

BATTERY BACK-UP KIT INSTALLATION

BLD-GM60R-HV sold separately:

1. Insert battery back-up in to the bracket and secure it with three screws. Attach junction box to the side of the bracket with two screws. Screw in mounting ring to the top and mounting hook to the bottom of the bracket. Secure them with 45° screws.
2. Attach bracket with battery to the ceiling using mounting ring. Attach lighting fixture to the mounting hook in the bottom of the bracket and secure it with screw.
3. Plug the fixture's power cable and circuit cable into the junction box. Make wiring according to the wiring diagram inside the junction box. Close junction box with cover and secure it with two screws.

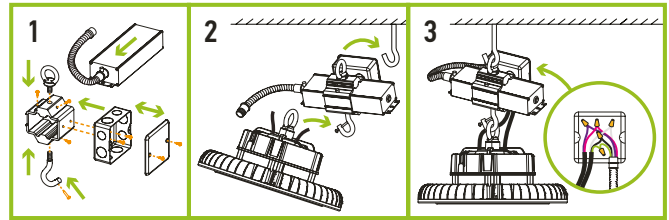

MOTION SENSOR KIT INSTALLATION (FIXTURES WITHOUT REFLECTOR, OR WITH PC REFLECTOR, OR WITH PC REFLECTOR AND CONICAL LENS):

1. Secure mounting plate for junction box to the fixture's radiator. Secure plastic junction box to the mounting plate.
2. Secure sensor with mounting plate to the fixture's radiator.
3. Wire the junction box in accordance with the wiring diagram and secure with screws caps. Close junction box.

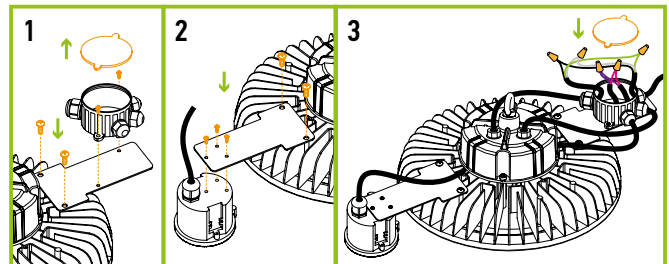

For most up-to-date spec sheets please refer to asd-lighting.com



LED UFO HIGH BAY

ORDERING INFORMATION

Model	Pcs. per carton	Carton size	Carton weight	UPC	GTIN 14
UHB2					
ASD-UHB2-100D35-PRM	1	10.6' x 10.6' x 7.1'	7.7 lbs	810050734523	-
ASD-UHB2-100D50W-PRM	1	10.6' x 10.6' x 7.1'	7.7 lbs	810050733298	-
ASD-UHB2-100D50-PRM	1	10.6' x 10.6' x 7.1'	7.7 lbs	819201023486	-
ASD-UHB2-150D35-PRM	1	10.6' x 10.6' x 7.7'	7.7 lbs	810050734530	-
ASD-UHB2-150D40W-PRM	1	10.6' x 10.6' x 7.7'	7.7 lbs	810050733304	-
ASD-UHB2-150D50W-PRM	1	10.6' x 10.6' x 7.7'	7.7 lbs	810050733311	-
ASD-UHB2-150D50-PRM	1	10.6' x 10.6' x 7.7'	7.7 lbs	819201023493	-
ASD-UHB2-150A50-BK	1	11.6' x 11.6' x 6.3'	5.5 lbs	810128114936	-
ASD-UHB2-200D35-PRM	1	10.6' x 10.6' x 7.7'	7.7 lbs	810050734547	-
ASD-UHB2-200D40W-PRM	1	10.6' x 10.6' x 7.7'	7.7 lbs	810050733328	-
ASD-UHB2-200D50W-PRM	1	10.6' x 10.6' x 7.7'	7.7 lbs	810050733335	-
ASD-UHB2-200D50-PRM	1	10.6' x 10.6' x 7.7'	7.7 lbs	819201023509	-
ASD-UHB2-200A50-BK	1	11.6' x 11.6' x 6.3'	5.5 lbs	810128114943	-
ASD-UHB2-240D50W-PRM	1	13' x 13' x 7.3'	10.4 lbs	810050734516	-
ASD-UHB2-240D50-PRM	1	13' x 13' x 7.3'	10.4 lbs	819201024018	-
ASD-UHB2-240A50-BK	1	13.2' x 13.2' x 6.3'	6.8 lbs	810128114950	-
ASD-UHB2-300D50-PRM	1	13' x 13' x 8.7'	12.1 lbs	819201025855	-
ASD-UHB2-400D50-PRM	1	16.1' x 16.1' x 9.6'	18.1 lbs	810050735490	-
ASD-UHB2-500D50-PRM	1	16.1' x 16.1' x 9.6'	18.1 lbs	810050735209	-
UHB2-HE					
ASD-UHB2-HE-240D50-BK	1	11.4' x 11.4' x 7.3'	8.6 lbs	810128112192	-
ASD-UHB2-HE-500D50-BK	1	16.7' x 16.7' x 9.5'	22 lbs	810128112215	-
ASD-UHB2-HE-600D50-BK	1	18.5' x 18.5' x 11.6'	33.2 lbs	810128112222	-
UHB2HV HIGH VOLTAGE					
ASD-UHB2HV-150D50-PRM	1	10.6' x 10.6' x 7.7'	8.4 lbs	819201023523	-
ASD-UHB2HV-200D50-PRM	1	10.6' x 10.6' x 7.7'	10.6 lbs	819201023530	-
ASD-UHB2HV-300D50-PRM	1	14.8' x 14.8' x 10.1'	15.7 lbs	810050736923	-
ASD-UHB2HV-400D50-PRM	1	16.1' x 16.1' x 10.6'	24.9 lbs	810050736305	-
ASD-UHB2HV-500D50-PRM	1	16.2' x 16.2' x 11.4'	25.4 lbs	810050736312	-
UHB22-MS WITH MOTION SENSOR					
ASD-UHB22-100D50-MS	1	10.6' x 10.6' x 8.1'	8.4 lbs	819201026937	-
ASD-UHB22-150D50-MS	1	10.6' x 10.6' x 8.1'	8.4 lbs	819201026944	-
ASD-UHB22-200D50-MS	1	11.8' x 11.8' x 8.7'	11.2 lbs	819201026951	-
ASD-UHB22-240D50-MS	1	11.8' x 11.8' x 8.7'	11.2 lbs	819201026968	-

ACCESSORIES:

Model	Description	UPC	Pcs. per carton	Carton size	Carton weight	GTIN 14
UHB-MSK1	Microwave motion sensor kit	819201021994	40	20.7' x 12.8' x 19.1'	44.1 lbs	10819201021991
UHB-RC-MSK1	Remote control for motion sensor	819201022007	100	14.5' x 12.8' x 12.2'	0.1 lbs	10819201022004
UHBHV-MSK2	Microwave motion sensor kit for 277-480V	819201025848	32	21.9' x 14.8' x 12.6'	29.8 lbs	20819201025842
ASD-CELP02H-MS	Remote control for motion sensor high voltage	819201023479	50	11.4' x 6.5' x 5.3'	6.6 lbs	10819201023476
BLD-RM40R	Battery back-up kit 40W	810050738507	4	23.6' x 13.8' x 7.9'	32.5 lbs	20810050738501
BLD-RM60R	Battery back-up kit 60W	810128112154	4	23.6' x 13.8' x 7.9'	37.7 lbs	20810128112158
BLD-GM60R-HV	Battery back-up kit 60W for 277-480V	810128112147	5	20.5' x 10.8' x 16.7'	41.9 lbs	10810128112144
RN1	Remote test switch for battery back-up kit	810050735223	50	13' x 9.8' x 6.5'	8.3 lbs	20810050735227
ASD-H-M10	Spring hook M10	819201025312	50	12.6' x 7.7' x 6.9'	12.1 lbs	20819201025316
ASD-H-M12	Spring hook M12	810050730556	50	12.6' x 7.7' x 6.9'	17.6 lbs	10810050730553
ASD-HS-M10	Screw-bolt hook M10	810050731164	50	11.9' x 8.3' x 9.1'	12.6 lbs	10810050731161
ASD-PMB-UHB	Pendant mount bracket	810050731522	50	13.9' x 9.7' x 7.1'	33.7 lbs	10810050731529
ASD-PMBJB-UHB	Pendant mount bracket with J-box and spring hook	810050736992	20	17.2' x 11.3' x 11.2'	30.9 lbs	10810050736999
ASD-SMB100/300-UHB2W	Surface mount bracket white for 100-300W	810050735339	20	22' x 18' x 13.9'	38.7 lbs	10810050735336
ASD-SMB100/300-UHB2	Surface mount bracket black for 100-300W	819201026999	20	22' x 18' x 13.9'	38.7 lbs	10819201026996
ASD-SMB400/500-UHB2	Surface mount bracket black for 400-500W	810050739801	10	14' x 18.3' x 20.3'	44.1 lbs	10810050739808
ASD-BLUHB-16PC	Polycarbonate bottom conical lens for 16"	819201020645	10	16.8' x 16.8' x 9.5'	12.8 lbs	10819201020642
ASD-BLUHB-19PC	Polycarbonate bottom conical lens for 19"	819201020652	10	20.7' x 19.6' x 6.9'	16.1 lbs	10819201020659
ASD-DUHB-16-90PC	Polycarbonate reflector 16" 90°	819201020607	10	16.7' x 16.7' x 7.5'	10.6 lbs	10819201020604
ASD-DUHB-19-90PC	Polycarbonate reflector 19" 90°	819201020614	10	19.7' x 19.7' x 9.1'	16.1 lbs	10819201020611
ASD-DUHB-16-90AL	Aluminum reflector 16" 90°	819201020621	10	16.7' x 16.7' x 7.5'	10.1 lbs	20819201020625
ASD-DUHB-21-120ALG	Aluminum reflector 21" 120°	819201020638	10	22' x 22' x 7.5'	14.6 lbs	10819201020635

For most up-to-date spec sheets please refer to asd-lighting.com